

HYP 2018



Josef Pochodzalla, HIM & Univ. Mainz, European Union

Introduction on neutral baryonic systems



NUCLEAR PHYSICS

Four neutrons together momentarily

A system of four neutrons known as the tetraneutron is a hypothetical state in nuclear physics. The report of evidence for the fleeting existence of this state has implications for research into neutron stars.

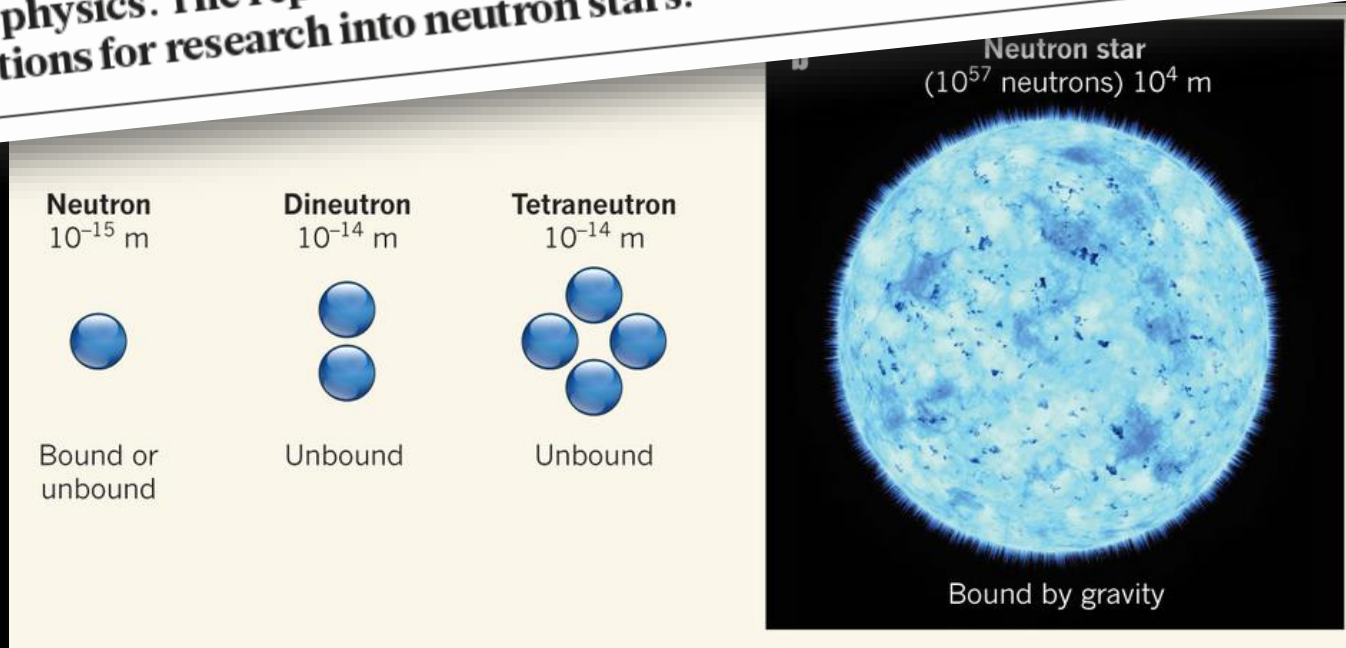

$A=2$

nn

$n\Lambda$

Σ^-p

$\Lambda\Lambda \dots$

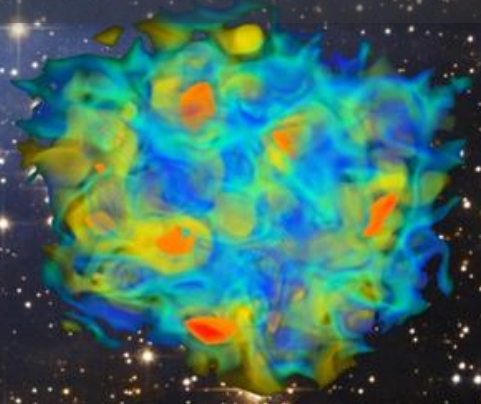
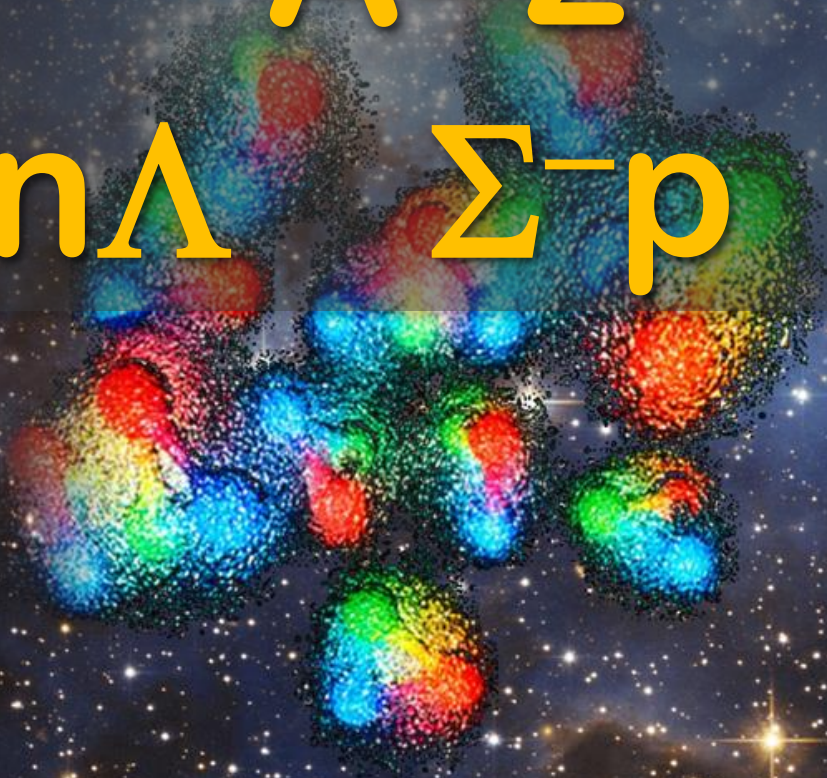

- Direct detection of neutral systems difficult
- final state interaction $d(n,p)2n$ or p - p correlations in HI
 - Problem: other hadrons present spoil the clear interpretation

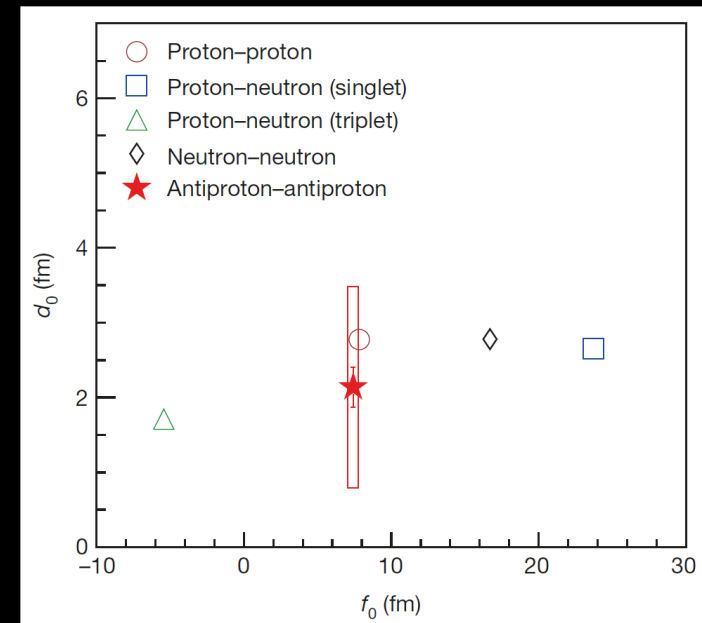
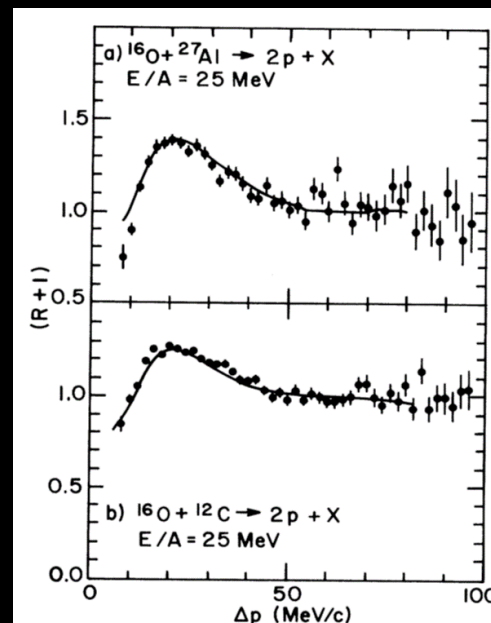
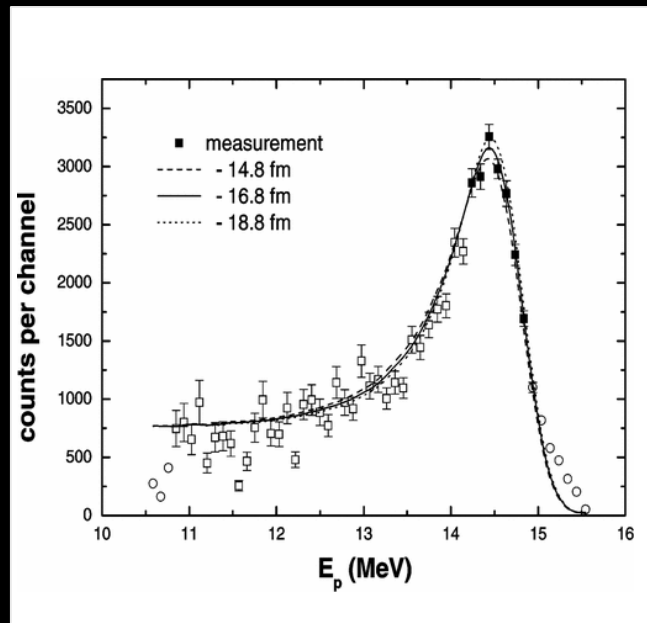

W. von Witsch *et al.*,
Phys. Rev. C 74, 014001 (2006)

M.A. Bernstein *et al.*,
Phys. Rev. Lett. 54, 402 (1985)

STAR Collaboration, Nature 527, 345 (2015)

- The deuterium singlet state is the only bound state
- The question of binding or not is small compared to total mass
- Replacing a neutron by a Λ can produce bound states ${}^5_{\Lambda}\text{He}$ ${}^8_{\Lambda}\text{Be}$

- FSI in $d(e,e'K^+)$
- K^+ capture on d (E91-016)
- FSI in HI reactions

Talk by L. Fabbietto

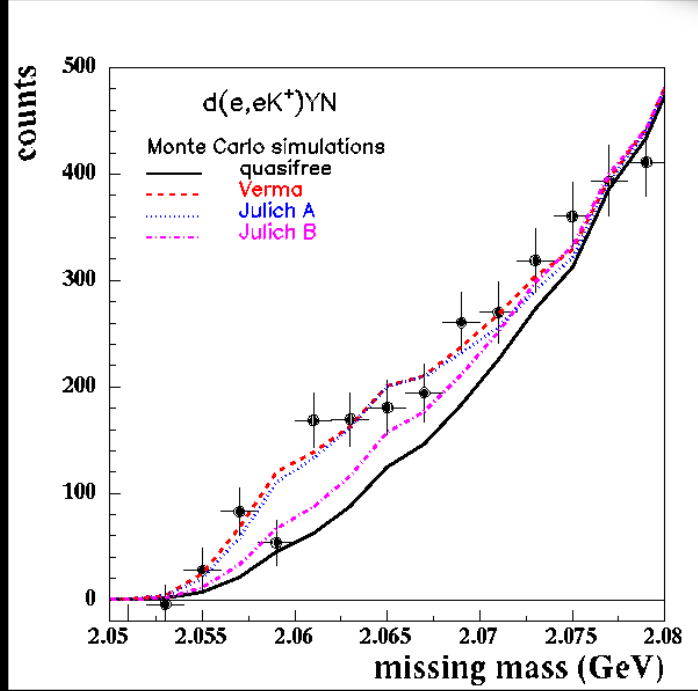

E91-016 (J. Reinhold)

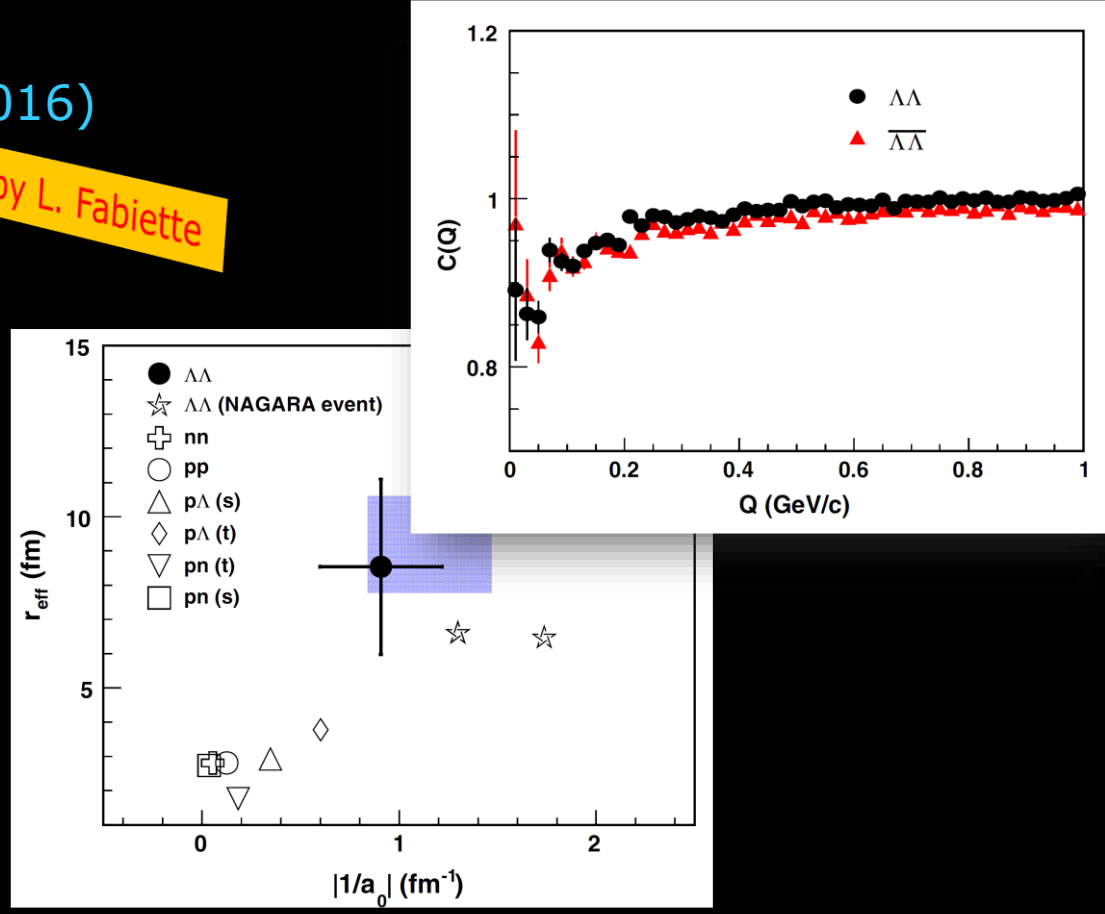

L. Adamczyk et al., Phys. Rev. Lett. 114, 022301 (2015)

- Future:
 - Scattering experiments with Σ^- hyperons @ J-PARC, $p\Lambda$ @ CLAS
 - Tagged hyperons in a mini- $\bar{p}p$ collider at FAIR or JPARC ?



A=3

nnn

nn Λ

n $\Lambda\Lambda$

See Talk by
Humberto Garcilazo

A short summary on the search of trineutron and tetra-neutron

Roman Ya. Kezerashvili^{1,2}

¹Physics Department, New York City College of Technology, The City University of New York,
Brooklyn, NY 11201, USA

²The Graduate School and University Center, The City University of New York,
New York, NY 10016, USA

(Dated: August 23, 2016)

In light of a new experiment which claims an identification of tetra-neutron [3], we discuss the results of experimental search of trineutron and tetra-neutron in different nuclear reactions. A summary of theoretical studies for trineutron and tetra-neutron within variety of approaches such as variational methods, the method of Faddeev and Faddeev-Yakubovsky equations, and the method of hyperspherical harmonics are presented.

- Such a state has been suggested by the HypHI collaboration
- weak decay $nn\Lambda \rightarrow \pi - ^3\text{H}$
 \Rightarrow bound state
- Statistical Decay Model ${}^6_{\Lambda}\text{He}^*$ at $E_x = 40\text{MeV}$
 - Λ 30.7% $nn\Lambda$ 17.3%
 - ${}^3_{\Lambda}\text{H}$ 13.9% ${}^4_{\Lambda}\text{H}$ 29.2%
 - ${}^4_{\Lambda}\text{He}$ 3.9% ${}^5_{\Lambda}\text{He}$ 4.8%
- but: all modern state of the art ab initio theories do not allow a bound $nn\Lambda$ state
- Do we really understand the Λ -neutron interaction?
 - N-N scattering: 4000 data
 - Y-p scattering: 100 data
 - Y-n scattering: 0 data

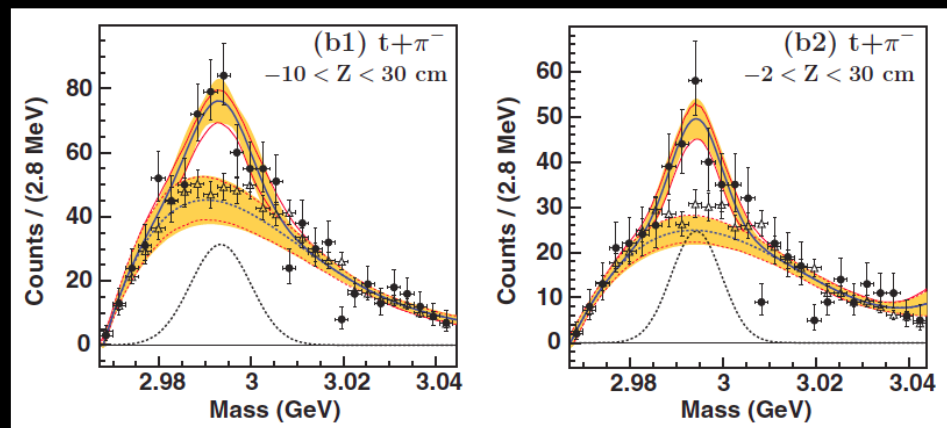

C. Rappold et al., Phys. Rev. C 88 , 041001(R) (2013)

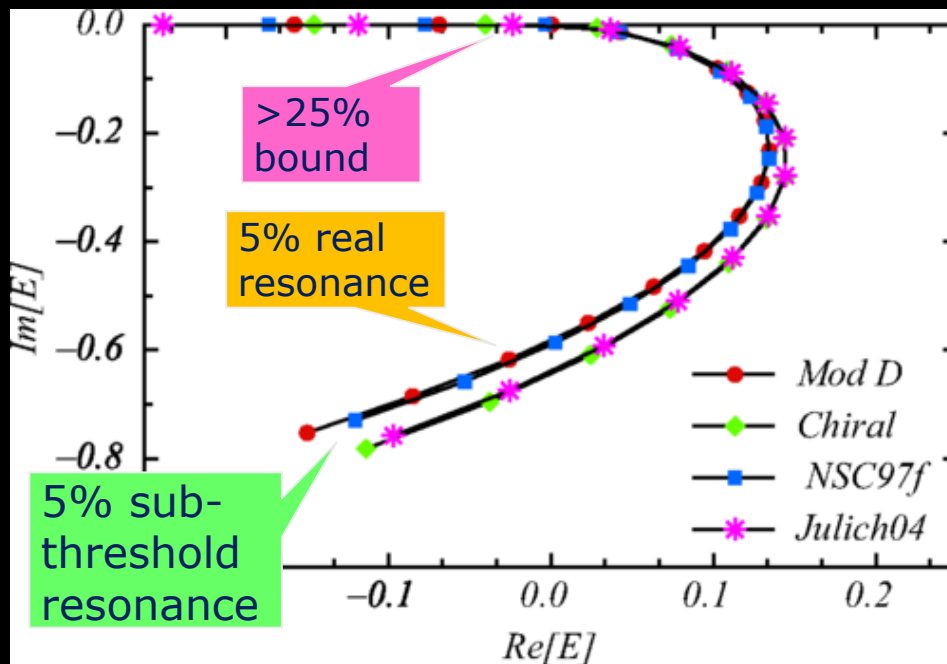

Iraj R. Afnan and Benjamin F. Gibson
 Phys. Rev. C 92, 054608

Approaching the $nn\Lambda$

See Talk by T. Saito on Friday

- 2018: J-Lab E12-17-003
 - ${}^3\text{H}(e, e'K^+)(nn\Lambda)$
 - missing mass experiment
 - will measure mass and width

- 2019: FRS+WASA for S447
 - ${}^6\text{Li}+{}^{12}\text{C}$
 - for $d+\pi^-$ 2x better mass resolution
 - 8 times better S/BG ratio
 - lifetime

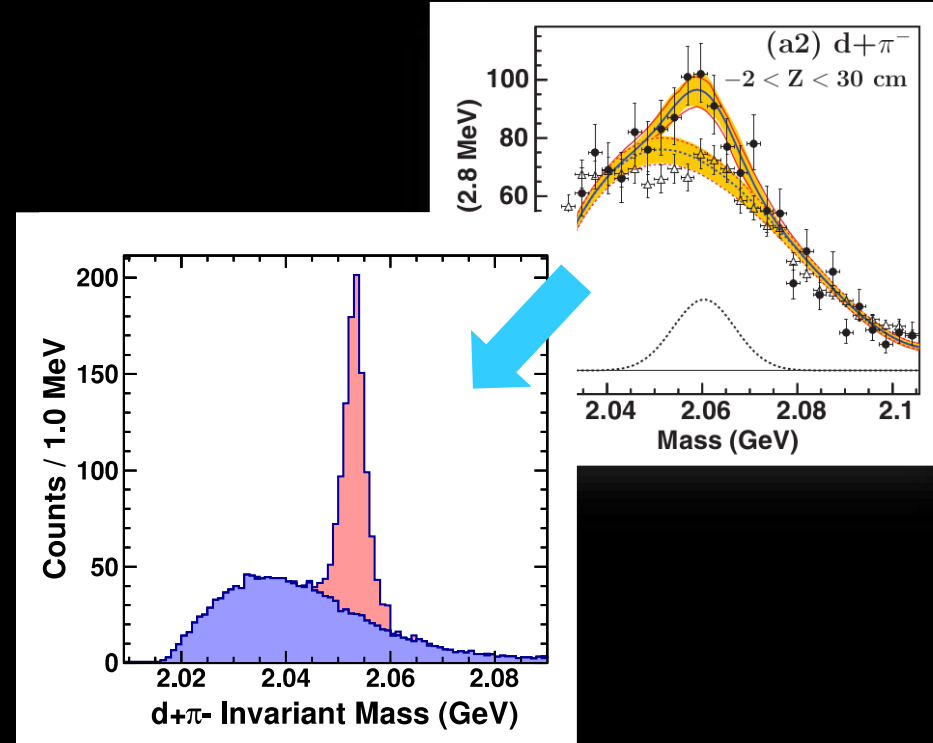
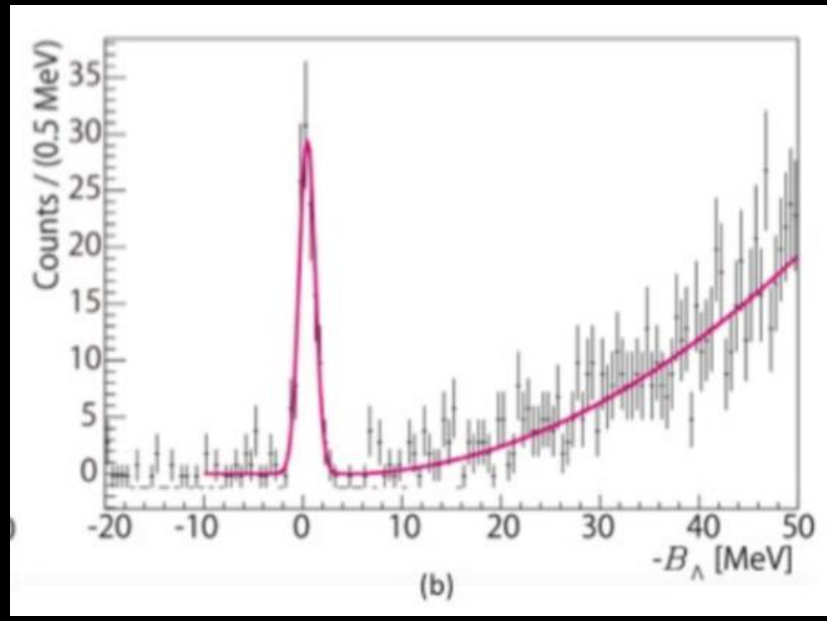

The existence of this „femto-neutron star“ would require to re-think our understanding of three-body interactions

Next HYP conference we will know the answer!

$A=4$

See Talk by Emiko
Hiyama

$nnnn$

$nn\Lambda\Lambda$

$nnn\Xi^0$

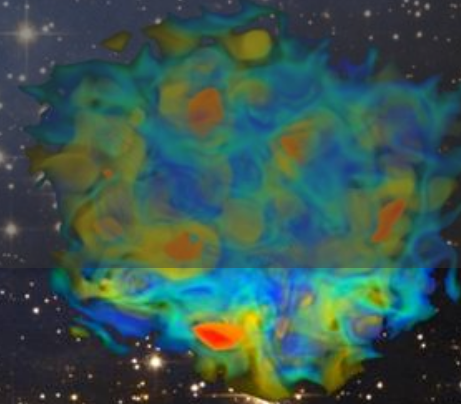
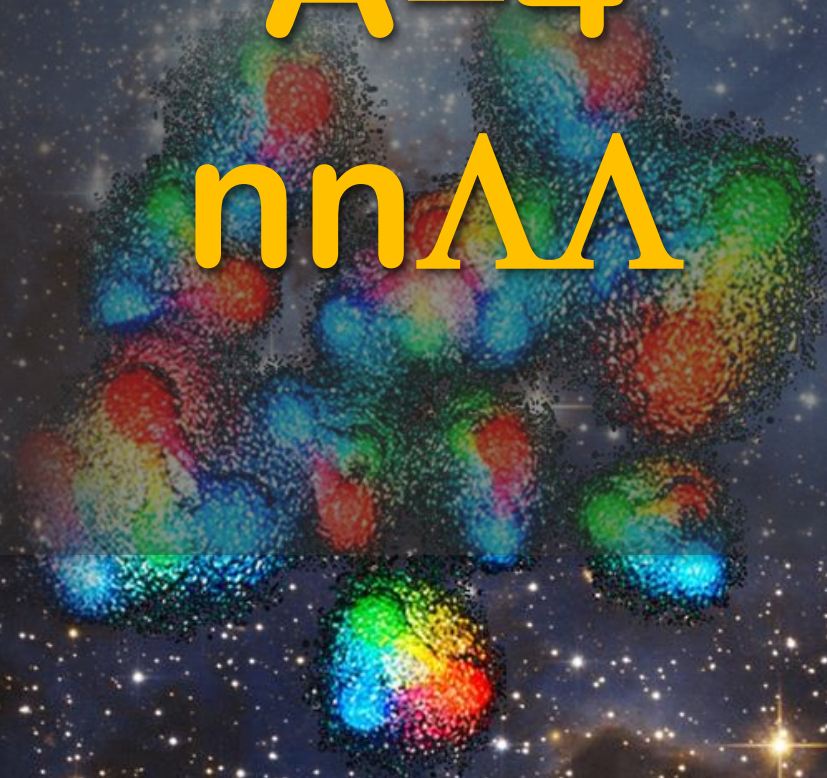

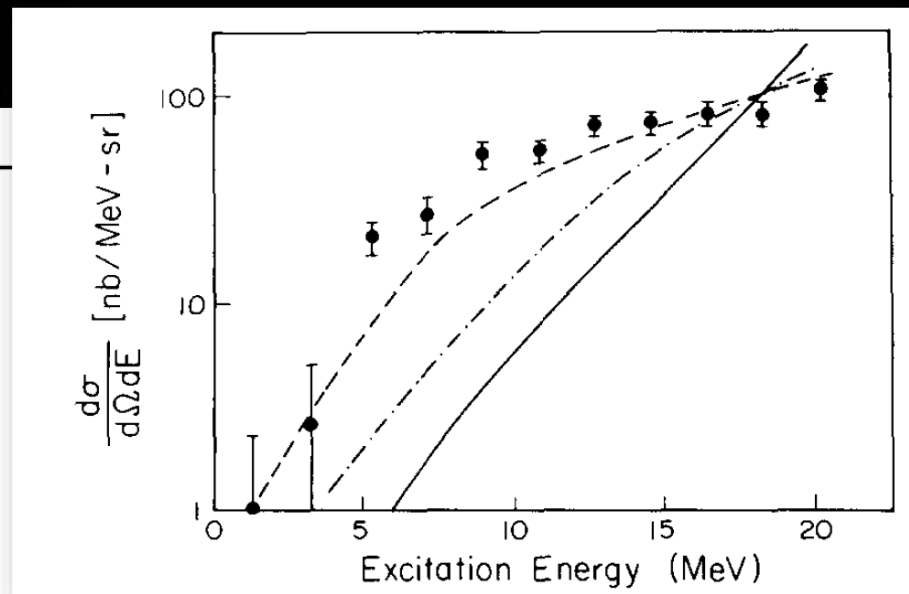
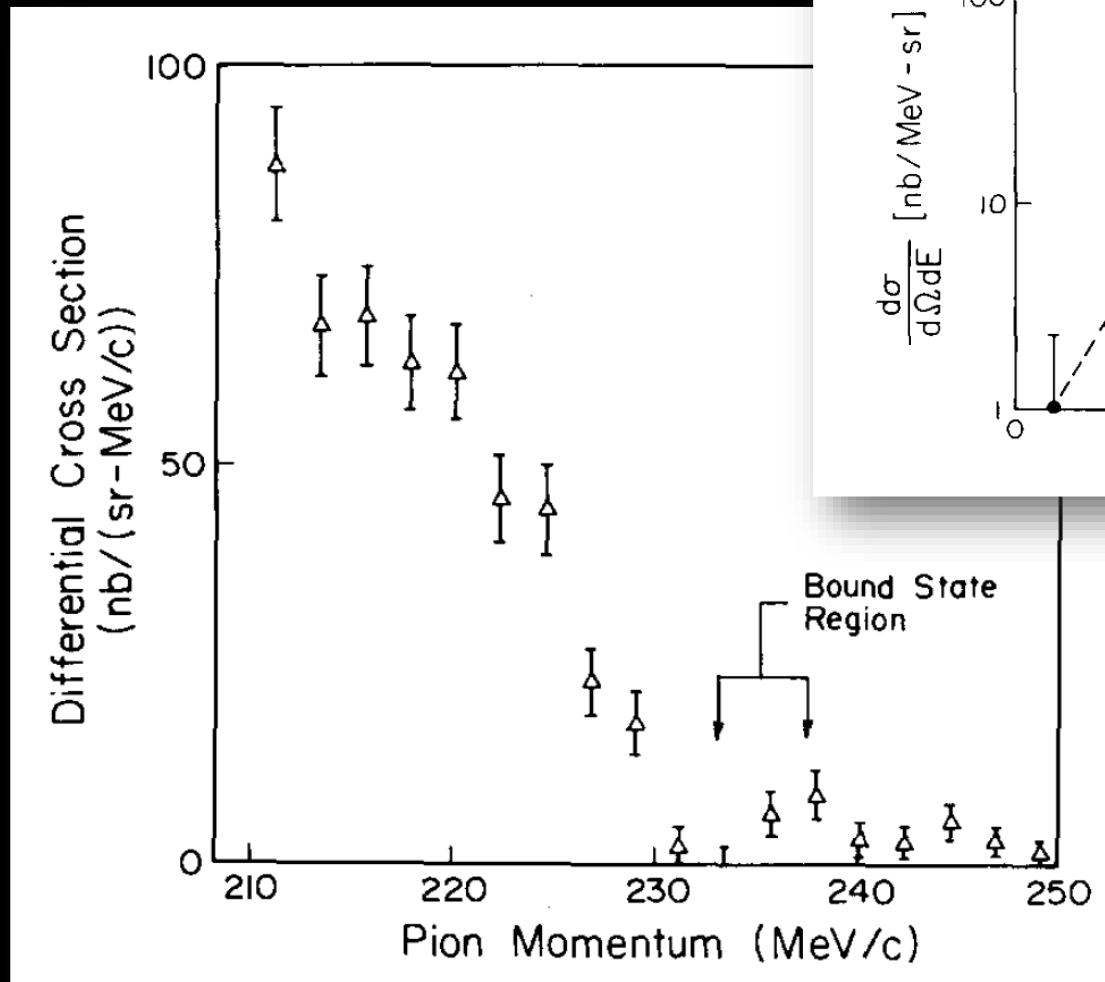

BRIEF REPORTS

Search for the tetraneutron using the reaction ${}^4\text{He}(\pi^-, \pi^+){}^4n$

A search for the production of bound tetraneutrons has been carried out with a time projection chamber using the reaction ${}^4\text{He}(\pi^-, \pi^+){}^4n$ at $T_{\pi^-} = 80$ MeV and at $50^\circ < \theta_{\text{lab}}^{\pi^+} < 130^\circ$. No evidence for tetraneutron formation was found, and a 90% confidence level upper limit for the production cross section of $d\sigma/d\Omega \leq 13$ nb sr $^{-1}$ was obtained.

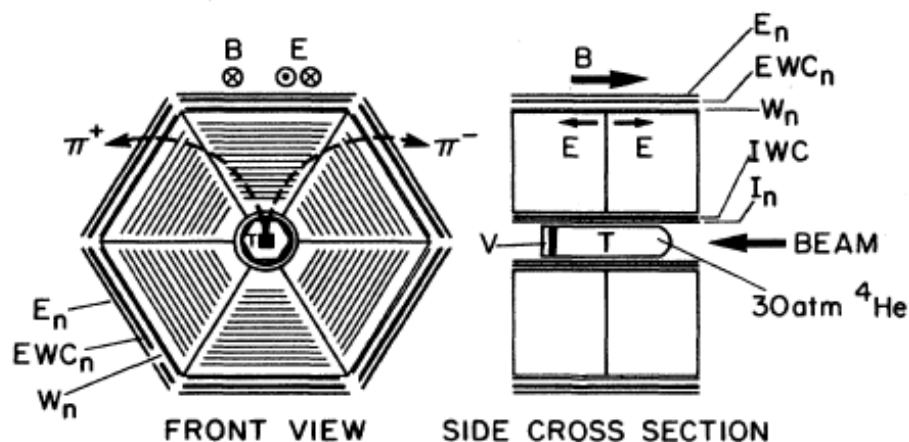

FIG. 1. The TPC front and side cross section. All the triggering counters (I_n , IWC, W_n , EWC_n , E_n) are shown as well as the direction of the magnetic (B) and electric (E) field, the beam direction (BEAM) and the target T . The twelve straight lines inside every sector of the TPC are the anode wires; the cathode pads under the anode wires are not shown. The two dashed semicircles coming from the center are examples of $x-y$ projections of tracks of negative and positive particles.

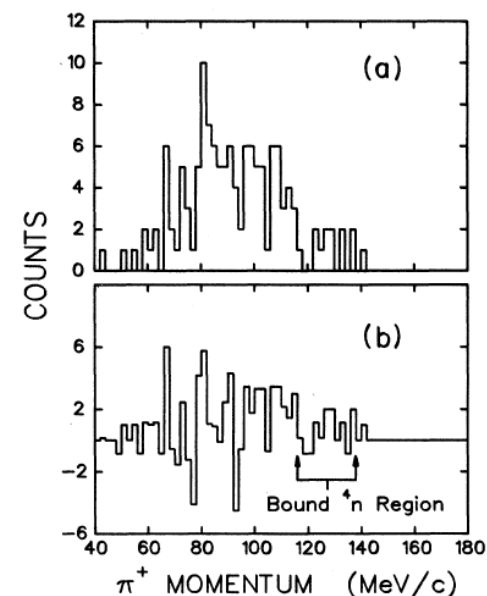
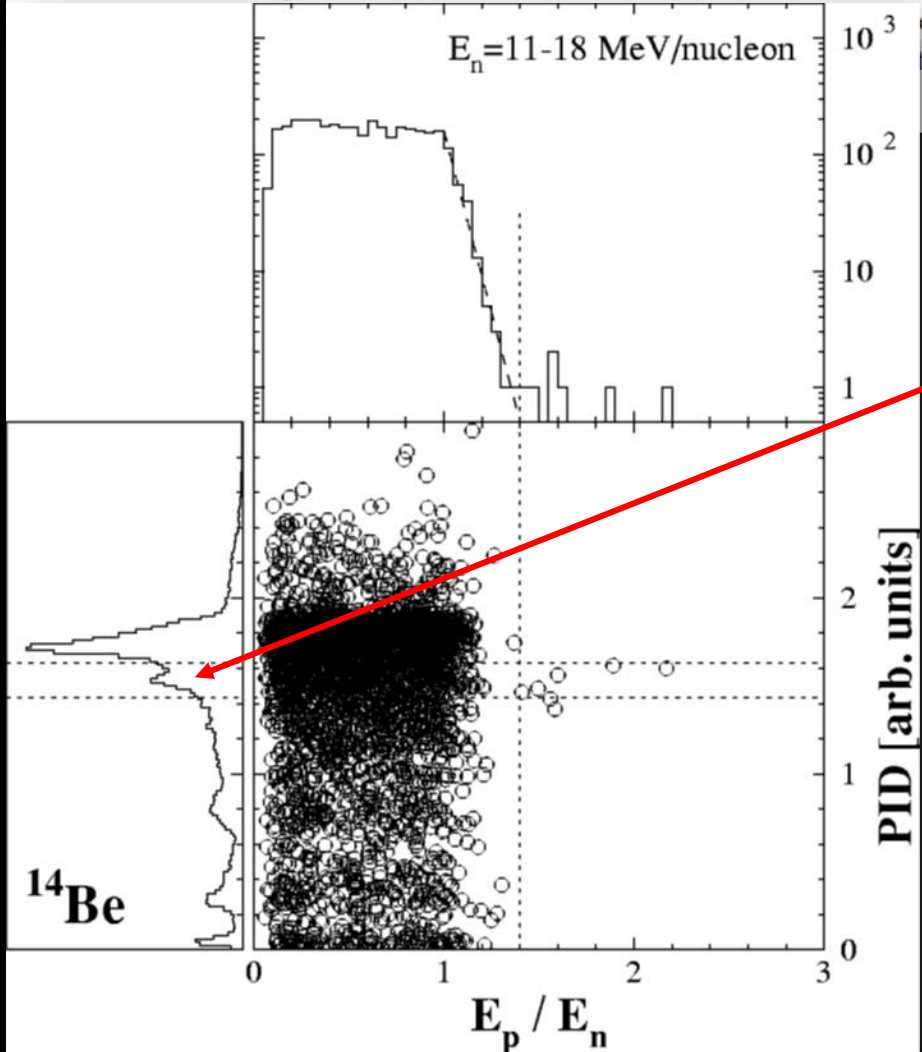
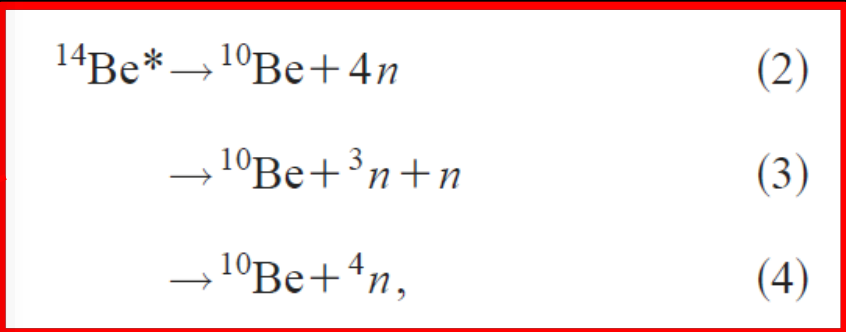

FIG. 4. (a) Measured π^+ momentum spectrum from ${}^4\text{He}(\pi^-, \pi^+)$ at $P_{\pi^-} = 170$ MeV/c ($T_{\pi^-} = 80$ MeV) and $\theta = 50^\circ - 130^\circ$, after all software cuts. The region corresponding to bound tetraneutron production (indicated by the arrows) contains 12 events. (b) The same spectrum after subtraction of the empty-target background. The region corresponding to tetraneutron production contains 6.1 events.

A new approach to the production and detection of bound neutron clusters is presented. The technique is based on the breakup of beams of very neutron-rich nuclei and the subsequent detection of the recoiling proton in a liquid scintillator. The method has been tested in the breakup of intermediate energy (30–50 MeV/nucleon)



ed that exhibit the characteristics of a multineutron the channel $^{10}\text{Be} + 4n$. The various backgrounds that



➤ ...but bound tetra-neutron is theoretically nearly impossible.

▶ Double charge exchange reaction

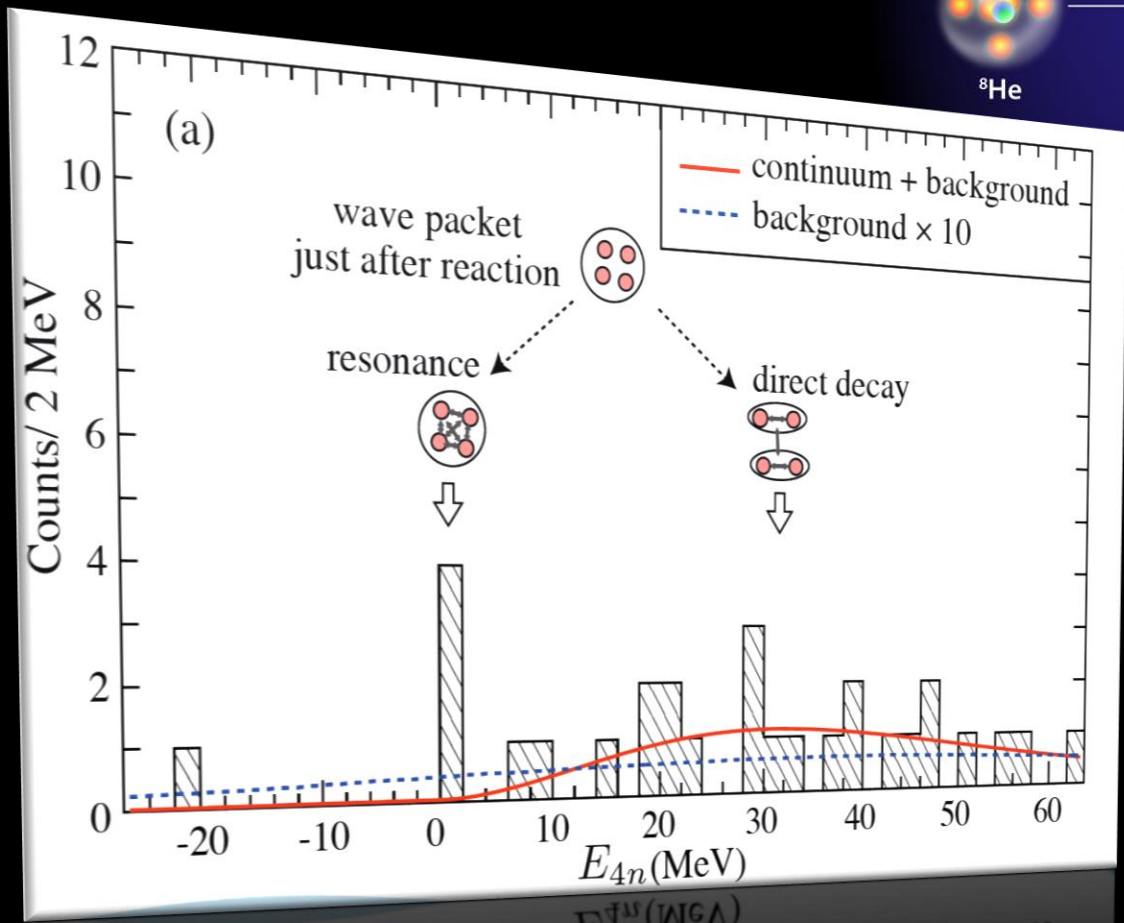
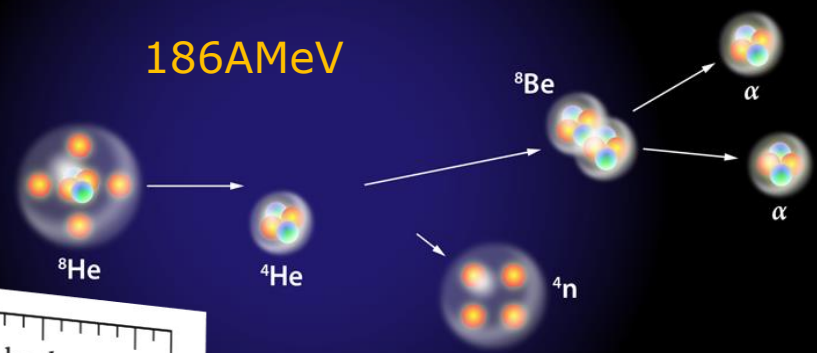

Can Modern Nuclear Hamiltonians Tolerate a Bound Tetraneutron?

Steven C. Pieper*

Physics Division, Argonne National Laboratory, Argonne, Illinois 60439, USA
 (Received 18 February 2003; published 27 June 2003)

I show that it does not seem possible to change modern nuclear Hamiltonians to bind a tetraneutron without destroying many other successful predictions of those Hamiltonians. This means that, should a recent experimental claim of a bound tetraneutron be confirmed, our understanding of nuclear forces will have to be significantly changed. I also point out some errors in previous theoretical studies of this problem.

PHYSICAL REVIEW C 72, 034003 (2005)

Is a physically observable tetraneutron resonance compatible with realistic nuclear interactions?

Rimantas Lazauskas*

DPTA/Service de Physique Nucléaire, CEA/DAM Ile de France, BP 12, F-91680 Bruyères-le-Châtel, France

Jaume Carbonell†

Laboratoire de Physique Subatomique et de Cosmologie, 53, avenue des Martyrs, F-38026 Grenoble Cedex, France‡
 (Received 22 April 2005; published 20 September 2005)

The possible existence of four-neutron resonances close to the physical energy region is explored. Faddeev-Yakubovsky equations have been solved in configuration space using realistic nucleon-nucleon interaction models. Complex scaling and analytical continuation in the coupling constant methods were used to follow the resonance pole trajectories, which emerge out of artificially bound tetraneutron states. The final pole positions for four-neutron states lie in the third energy quadrant with negative real energy parts and should thus not be physically observable.

On the existence of a bound tetraneutron

N. K. Timofeyuk

Physics Department, University of Surrey, Guildford, Surrey GU2 7XH, England, UK

(Dated: Received: December 25, 2013)

Following recent work in which events which may correspond to a bound tetraneutron (${}^4\text{n}$) were observed, it is pointed out that from the theoretical perspective the two-body nucleon-nucleon force cannot by itself bind four neutrons, even if it can bind a dineutron. A very strong phenomenological four-nucleon ($4N$) force is needed in order to bind the tetraneutron. Such a $4N$ force, if it existed, would bind ${}^4\text{He}$ by about 100 MeV. Alternative experiments such as (${}^8\text{He}, {}^4\text{n}$) are proposed to search for the tetraneutron.

See Talk by
Jaume CarbonellePHYSICAL REVIEW C **93**, 044004 (2016)**Possibility of generating a 4-neutron resonance with a $T = 3/2$ isospin 3-neutron force**

E. Hiyama

Nishina Center for Accelerator-Based Science, RIKEN, Wako, 351-0198, Japan

R. Lazauskas

IPHC, IN2P3-CNRS/Universite Louis Pasteur BP 28, F-67037 Strasbourg Cedex 2, France

J. Carbonell

Institut de Physique Nucléaire, Université Paris-Sud, IN2P3-CNRS, F-91406 Orsay Cedex, France

M. Kamimura

*Department of Physics, Kyushu University, Fukuoka 812-8581, Japan**and Nishina Center for Accelerator-Based Science, RIKEN, Wako 351-0198, Japan*

(Received 27 December 2015; revised manuscript received 26 February 2016; published 29 April 2016)

In conclusion, as far as we can maintain the consistency with the observed low-lying energy properties of the ${}^4\text{H}$, ${}^4\text{He}$ ($T = 1$), and ${}^4\text{Li}$ nuclei, it is difficult to produce an observable 4n resonant state.

four-body resonances. We find that to generate narrow 4n resonant states a remarkably attractive 3n force in the $T = 3/2$ channel is required.

Prediction for a Four-Neutron Resonance

A. M. Shirokov,^{1,2,3,*} G. Papadimitriou,^{4,†} A. I. Mazur,³ I. A. Mazur,³ R. Roth,⁵ and J. P. Vary^{2,‡}

¹*Skobeltsyn Institute of Nuclear Physics, Moscow State University, Moscow 119991, Russia*

²*Department of Physics and Astronomy, Iowa State University, Ames, Iowa 50011-3160, USA*

³*Pacific National University, 136 Tikhooskanskaya Street, Khabarovsk 680035, Russia*

⁴*Nuclear and Chemical Science Division, Lawrence Livermore National Laboratory, Livermore, California 94551, USA*

⁵*Institut für Kernphysik, Technische Universität Darmstadt, 64289 Darmstadt, Germany*

(Received 20 July 2016; revised manuscript received 9 September 2016; published 28 October 2016)

We utilize various *ab initio* approaches to search for a low-lying resonance in the four-neutron ($4n$) system using the JISP16 realistic NN interaction. Our most accurate prediction is obtained using a J -matrix extension of the no-core shell model and suggests a $4n$ resonant state at an energy near $E_r = 0.8$ MeV with a width of approximately $\Gamma = 1.4$ MeV.

DOI: 10.1103/PhysRevLett.117.182502

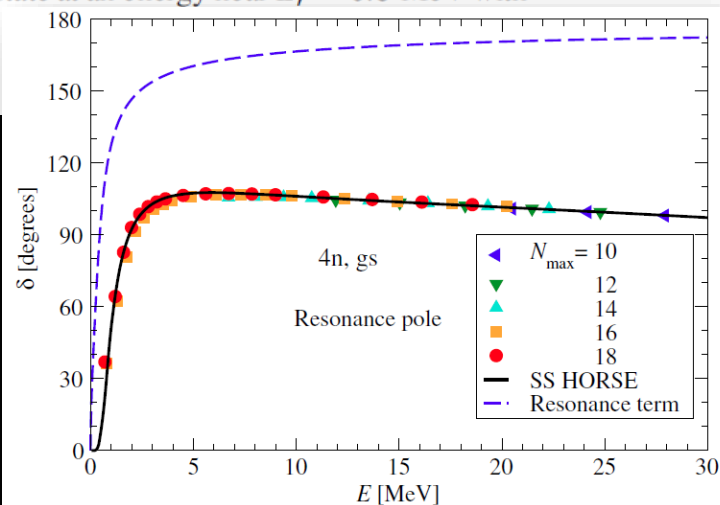

FIG. 2. The $4 \rightarrow 4$ scattering phase shifts: parametrization with a single resonance pole (solid line) and obtained directly from the selected NCSM results using Eq. (2) (symbols). The dashed line shows the contribution of the resonance term.

Is a trineutron resonance lower in energy than a tetra-neutron resonance?

S. Gandolfi,^{1,*} H.-W. Hammer,^{2,3,†} P. Klos,^{2,3,‡} J. E. Lynn,^{2,3,§} and A. Schwenk^{2,3,4,¶}

¹*Theoretical Division, Los Alamos National Laboratory, Los Alamos, New Mexico 87545, USA*

²*Institut für Kernphysik, Technische Universität Darmstadt, 64289 Darmstadt, Germany*

³*ExtreMe Matter Institute EMMI, GSI Helmholtzzentrum für Schwerionenforschung GmbH, 64291 Darmstadt, Germany*

⁴*Max-Planck-Institut für Kernphysik, Saupfercheckweg 1, 69117 Heidelberg, Germany*

We present quantum Monte Carlo calculations of few-neutron systems confined in external potentials based on local chiral interactions at next-to-next-to-leading order in chiral effective field theory. The energy and radial densities for these systems are calculated in different external Woods-Saxon potentials. We assume that their extrapolation to zero external-potential depth provides a quantitative

In this Letter, we have simulated two, three and four neutrons in external potentials and extrapolated to the zero well-depth limit. These extrapolations are independent of the trap geometry since different Woods-Saxon widths converge to the same energy at zero well depth.

We found a tetra-neutron resonance energy in agreement with recent measurements. Taken together with the results from the simple S -wave potential and the results mimicking the helium isotopic chain, our results suggest that a trineutron resonance may be lower in energy than a four-neutron resonance and therefore possibly experimentally observable. We also conclude that the effects

- Improve statistics at RIKEN
- Quasifree α knock out $^8\text{He}(p, p\alpha)$
- $^4\text{He}(\pi^-, \pi^+)$ reaction

See Talk by
Susum Shimoura

Hiroyuki Furoka *et al.*

Search for Tetraneutron by Pion Double Charge Exchange Reaction at J-PARC

Hiroyuki FUJIOKA¹, Tomokazu FUKUDA², Toru HARADA², Emiko HIYAMA³, Kenta ITAHASHI³,
Shunsuke KANATSUKI¹, Tomofumi NAGAE¹, Takuya NANAMURA¹, Takahiro NISHI³

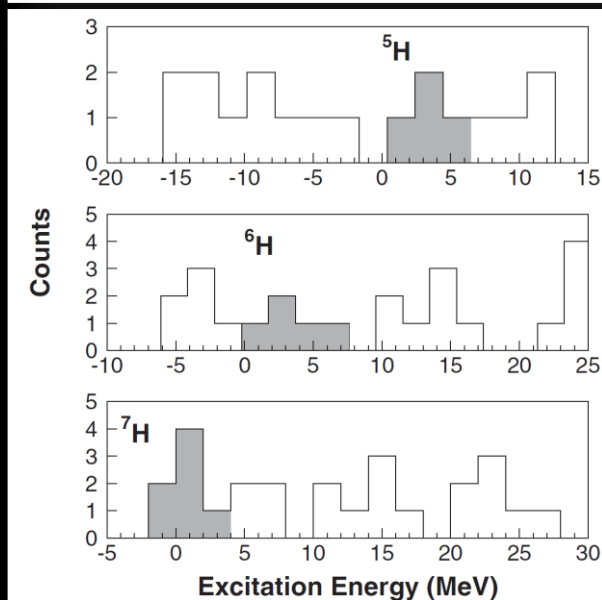

FIG. 3. Excitation energy distributions calculated under the assumptions of ^5H (top panel), ^6H (middle panel), and ^7H (bottom panel) production channels. The gray histograms in the ^5H and ^6H channels correspond to those events lying in the regions where the resonances were already observed in previous experiments. The gray histogram in the ^7H corresponds to those events identified as ^7H production. See text for details.

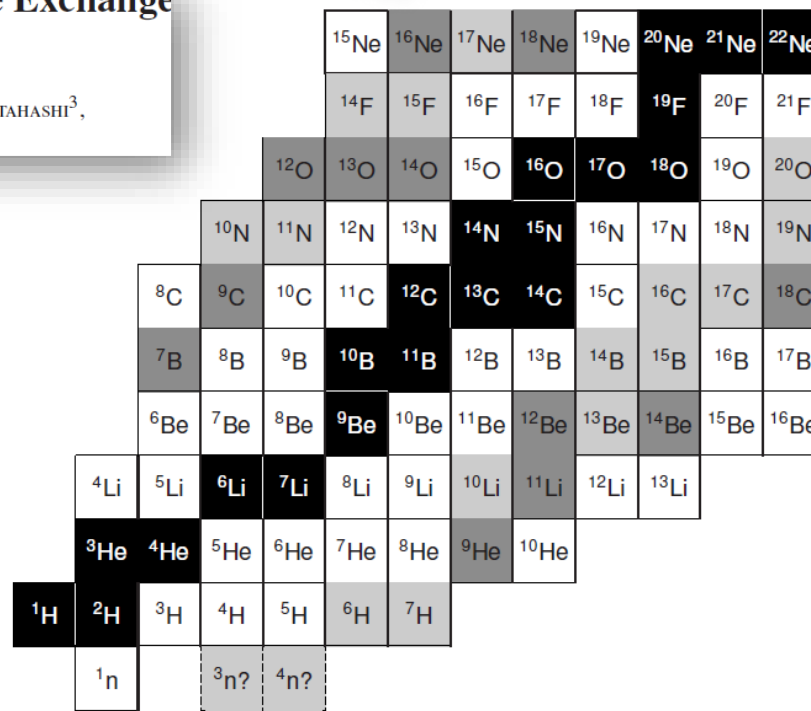

Fig. 1. A part of the nuclear chart ($Z \leq 10$ and $N \leq 12$). Stable nuclei and long-lived ^{14}C , which was used as a target in past pion DCX measurements, are represented by black squares. Gray squares correspond to nuclides accessible by the (π^\pm, π^\mp) reaction. Nuclides observed in pion DCX reactions [13] are highlighted in dark gray.

- Double π^+ production
- ${}^4\text{He}(e, e' \pi^+ \pi^+) \text{nnnn}$
- What is needed
 - Helium target ✓
 - 3 spectrometers ✓
 - MAMI-C ✓

- Short test experiment
- ${}^{12}\text{C}(e, e' \pi^+ \pi^+) {}^{12}\text{Be}$

- Setting
 - SPEK-B: e^- 600MeV/c $\theta = +15^\circ$
 - SPEK-C: π^+ 170MeV/c $\theta = +54^\circ$
 - SPEK-A: π^+ 590MeV/c $\theta = -23^\circ$

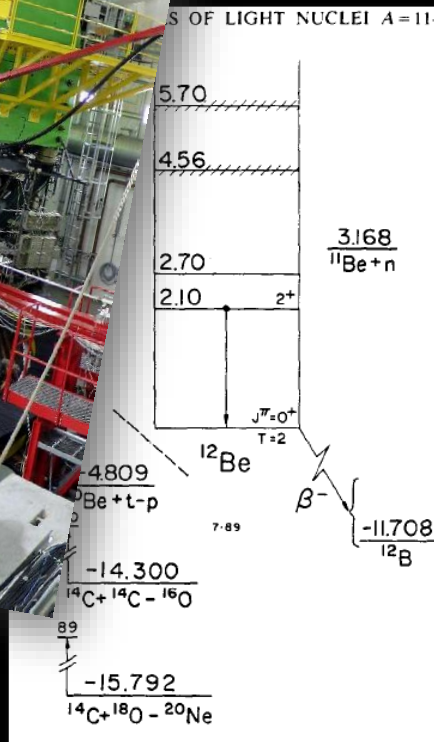
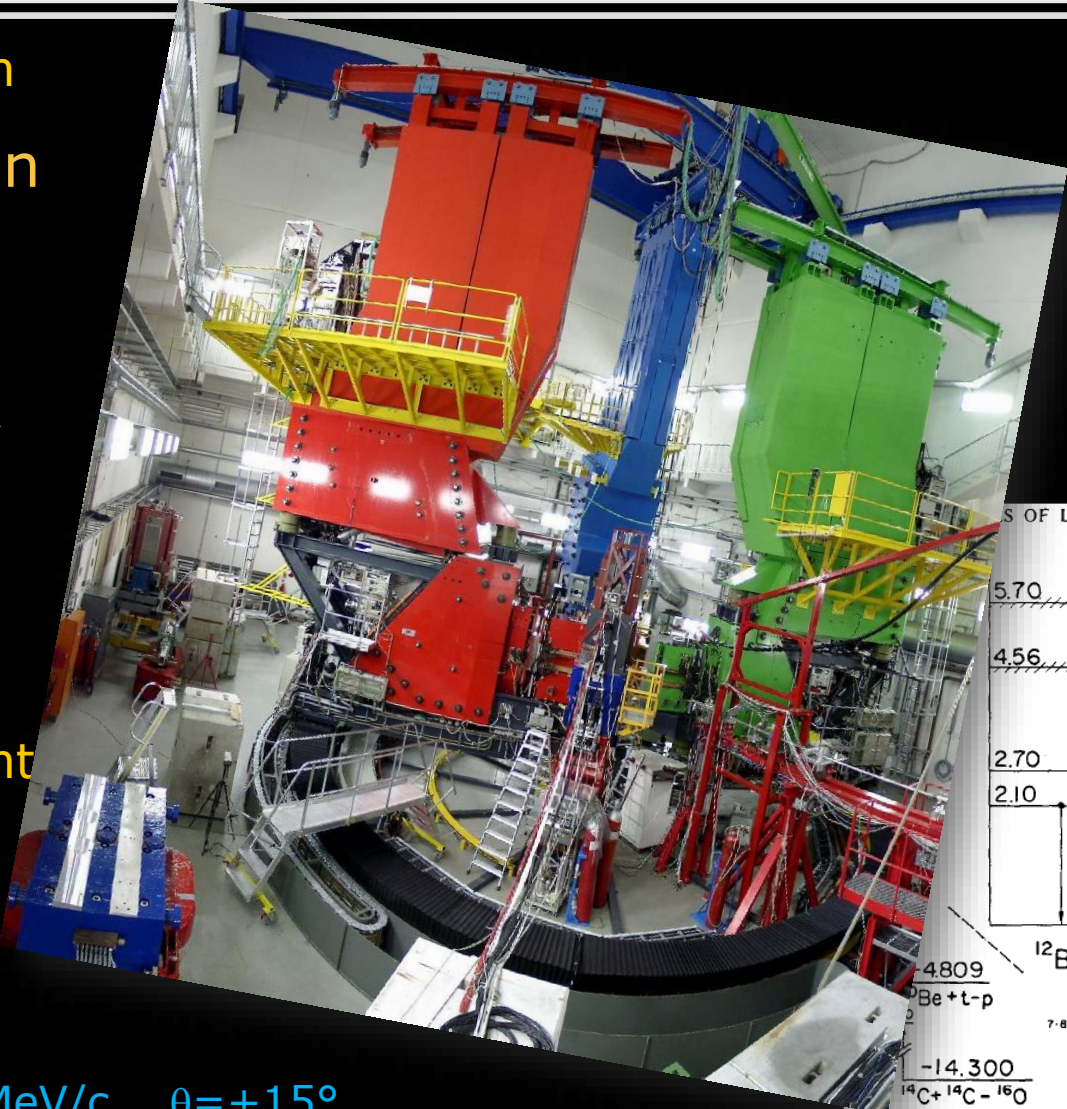
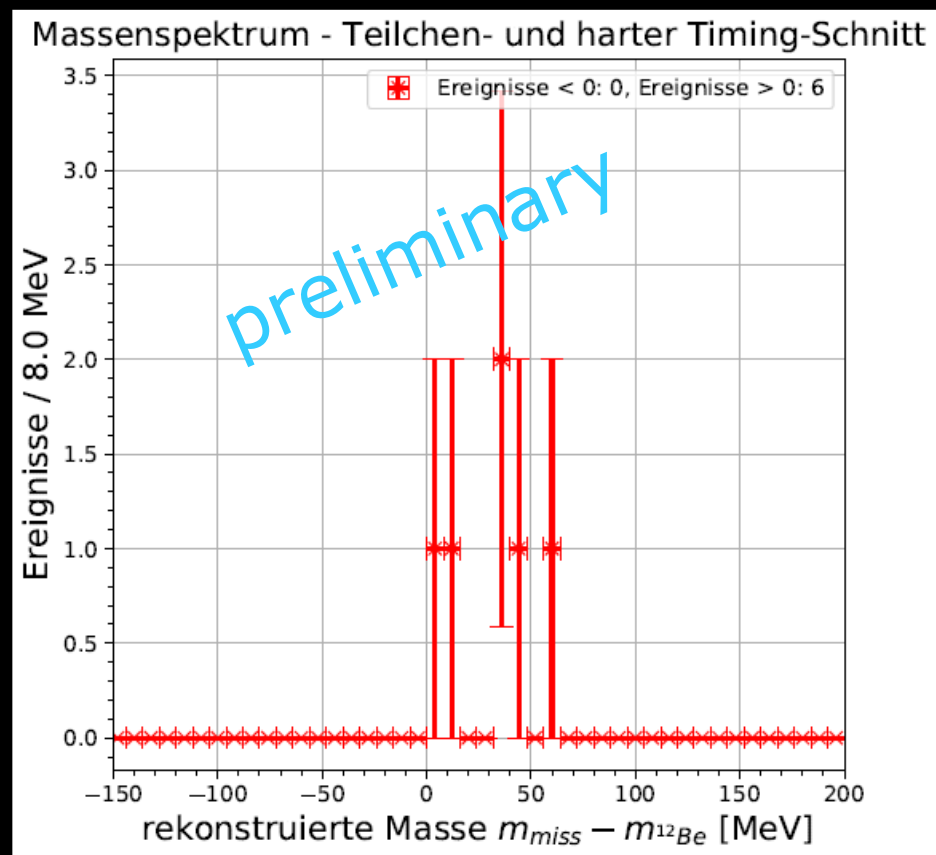
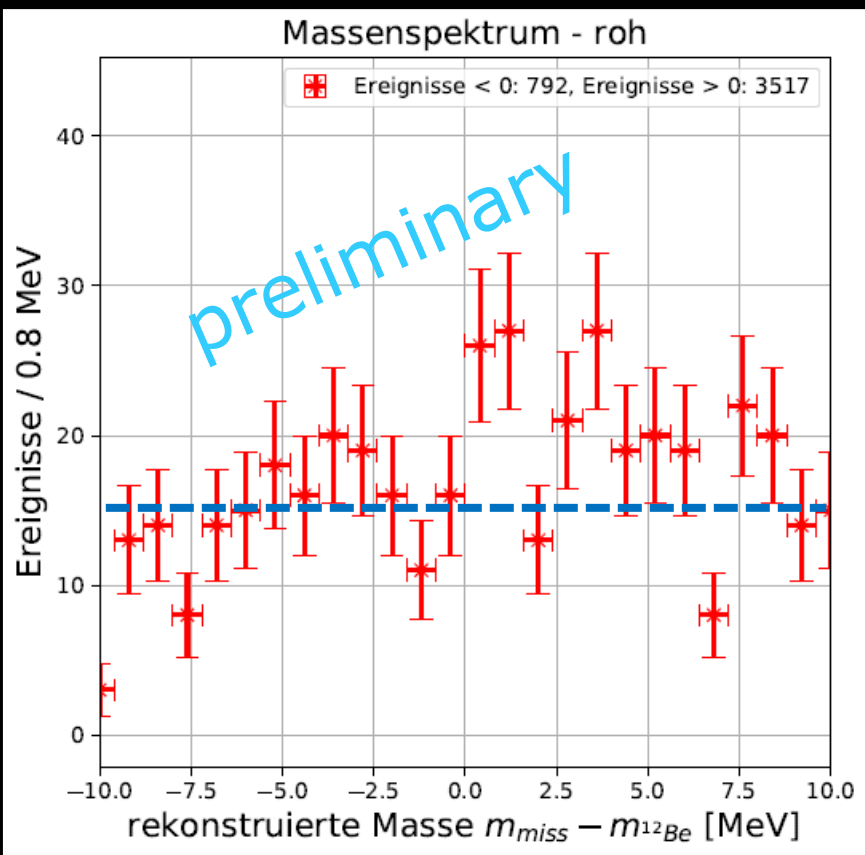
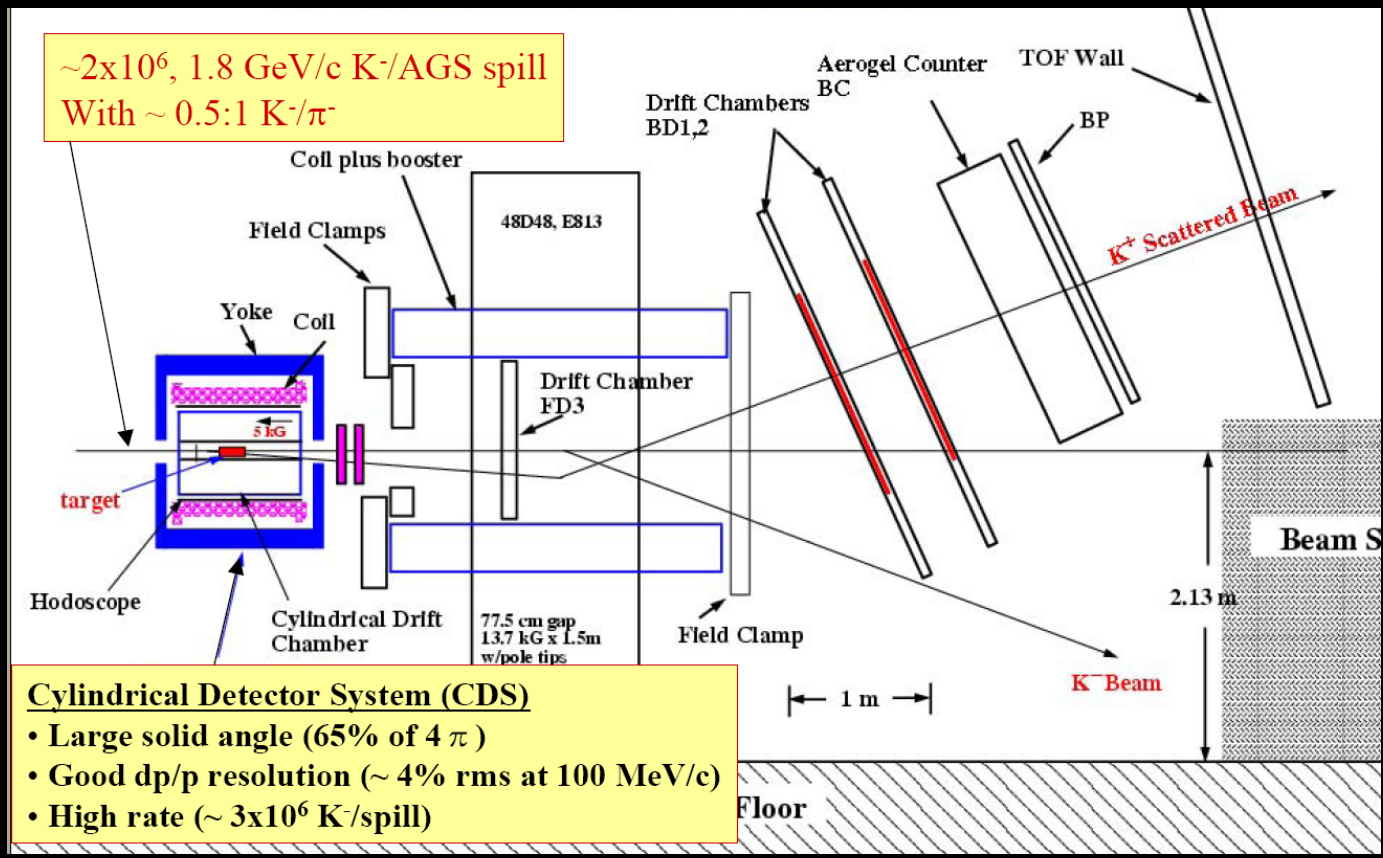
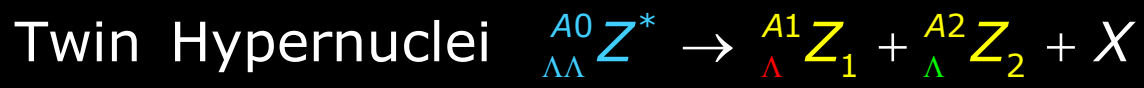
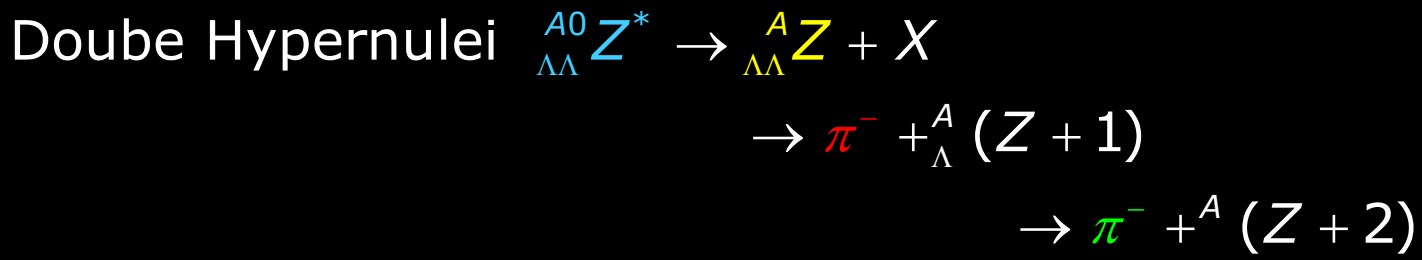

Fig. 5. Energy levels of ${}^{12}\text{Be}$: for notation see fig. 2.

- Preliminary result
- Not optimal/stable running conditions \Rightarrow calibration ?
- Neutron background in ToF detectors
 - relying only on particle \Rightarrow sizable background
 - Tide timing cut removes also most of real tripple coincidences



The E906: ${}^9\text{Be}(K^-, K^+ \pi^- \pi^-)$



K⁻

K⁺

beam
dump

consistent with
single Λ
hypernuclei

- $9 \cdot 10^{11}$ K^- on Be target
- $1.1 \cdot 10^5$ trigger

momentum of the pion with lower momentum

twin hypernuclei

114 MeV/c

133 MeV/c

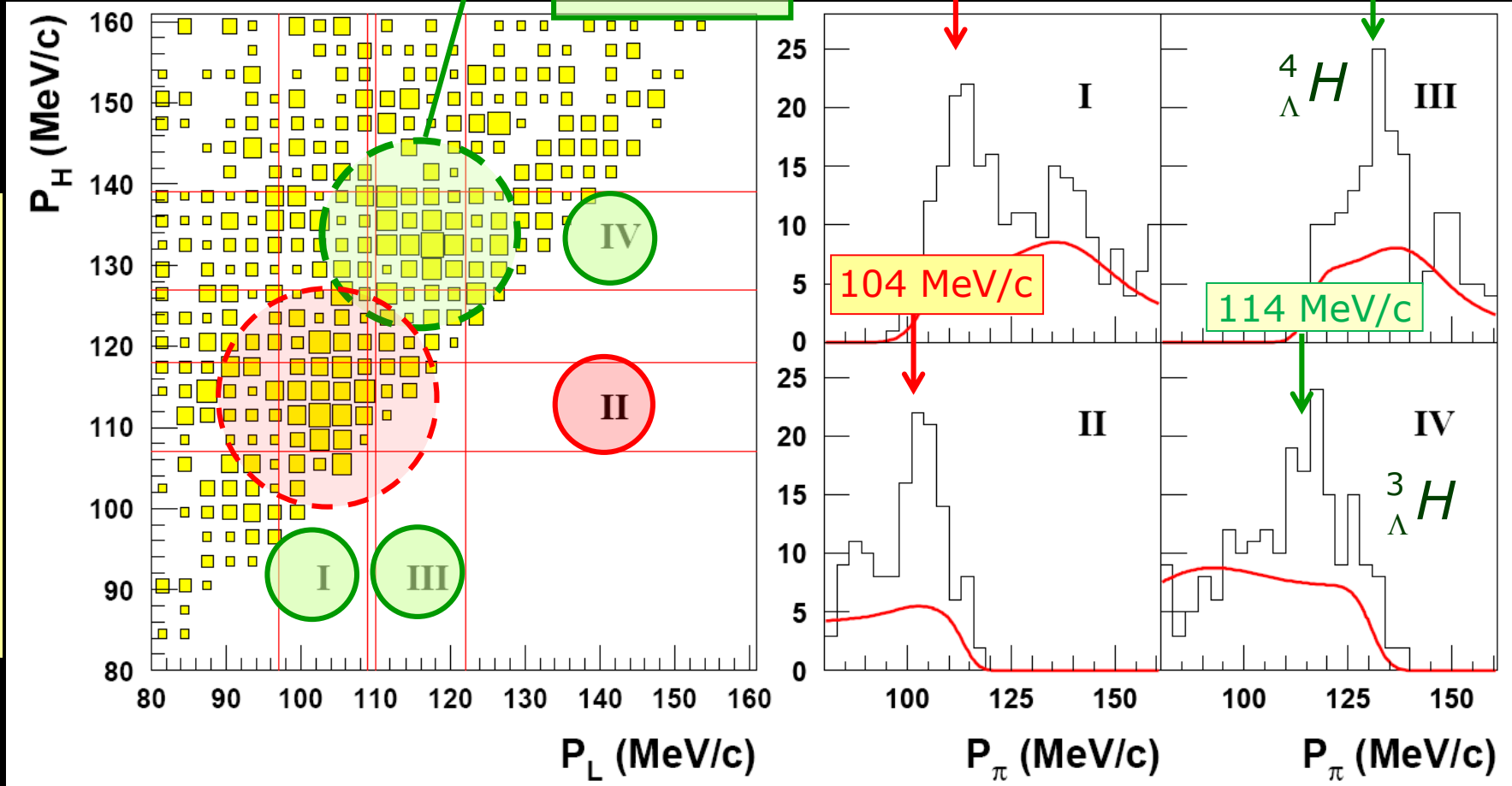

momentum of the pion with lower momentum

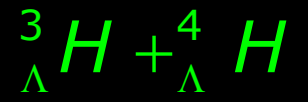
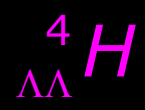

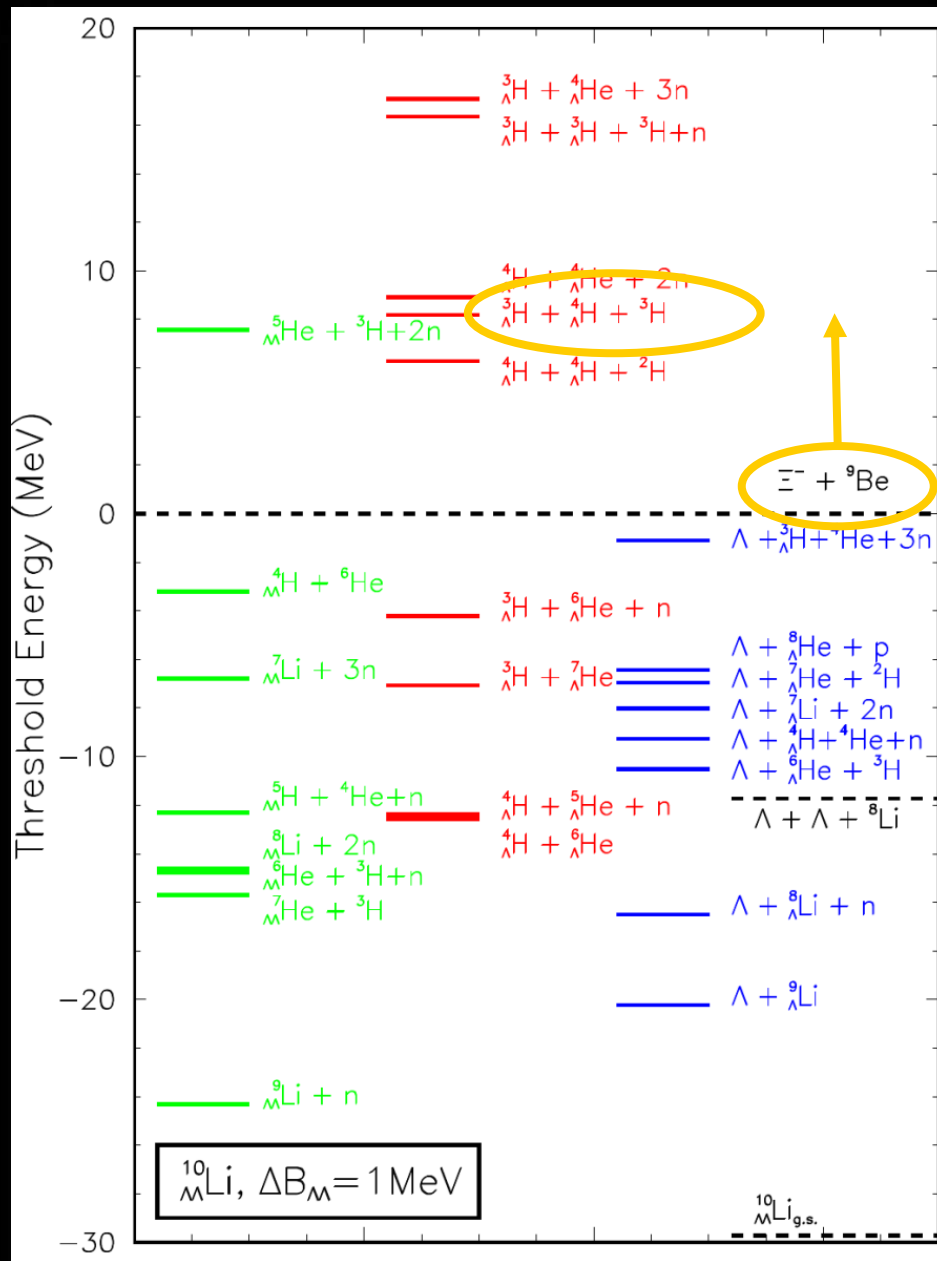

- GiBUU (T. Gaitanos) folded with momentum distribution of Ξ^- in ${}^9\text{Be}$ target.
 - Fujiwara Quark-Cluster model for $\Xi + N \rightarrow \Lambda + \Lambda$
 - Similar results with Rijken OBE model for $\Xi + N \rightarrow \Lambda + \Lambda$

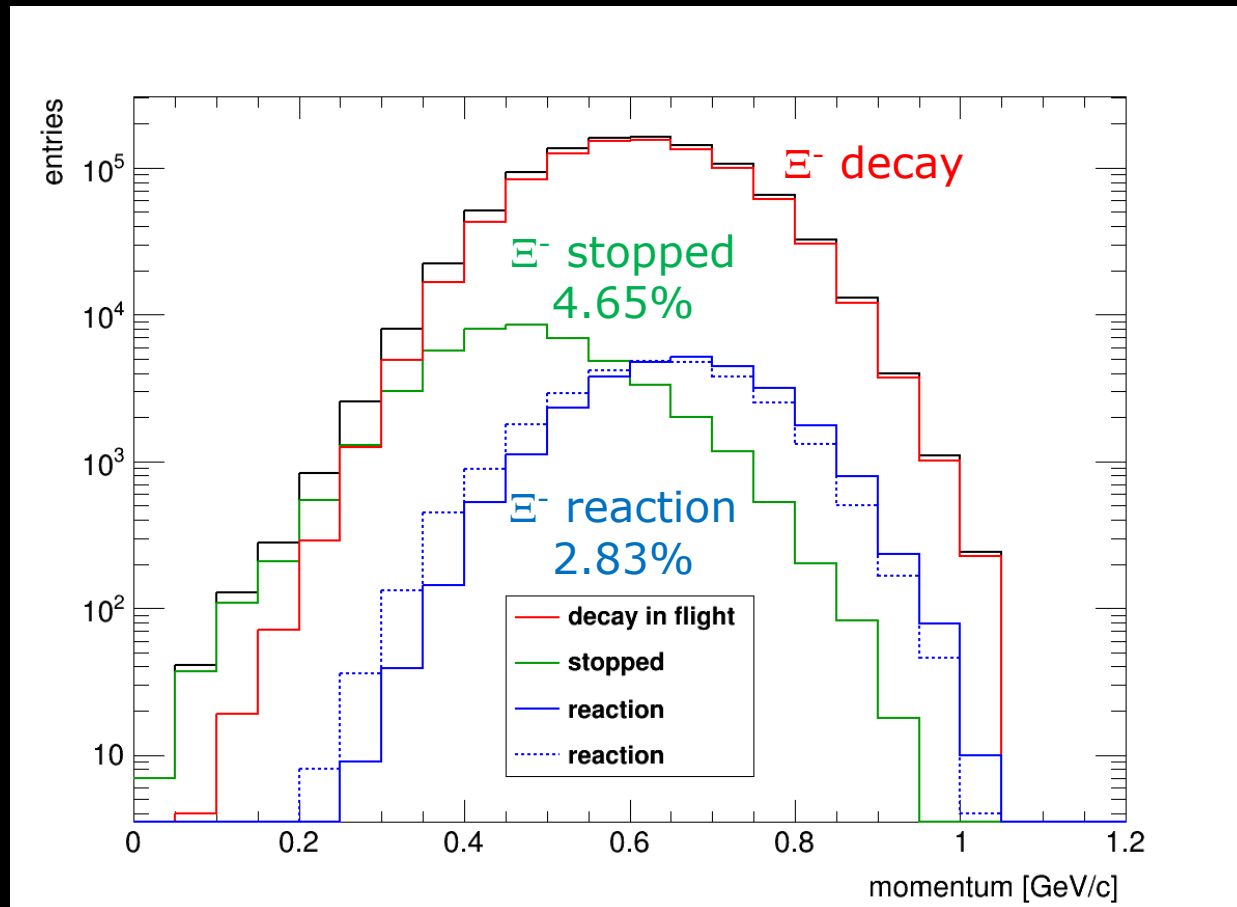

	Initial prob. [%]	$\Lambda+\Lambda$ [%]	$\Lambda+SH$ [%]	$SH+SH$ [%]	DH [%]	${}^3_{\Lambda}H+{}^4_{\Lambda}H$ [%]
SMM ${}^{10}_{\Lambda\Lambda}Li^*$	4.65	2.18	27.15	28.93	41.73	0
	<i>$\Xi \rightarrow \Lambda\Lambda$ capture and conversion of $5\% \times 4.65 / 2.83$</i>					
SMM ${}^{10}_{\Lambda\Lambda}Li^*$		0.18	2.75	2.89	4.21	0
GiBUU $\Xi^- + {}^9Be$	2.83	0.38	0.20	0.0009	0.03	0.0002

- Capture of stopped Ξ^- dominates hypernucleus production
- Production of ${}^3_{\Lambda}H+{}^4_{\Lambda}H$ pairs is unlikely!

➤ Gal, HYP2003

October 17, 2003

29

Another Possibility ${}^4_{\Lambda\Lambda}n$ (Gal)

104 X 114 MeV Lines

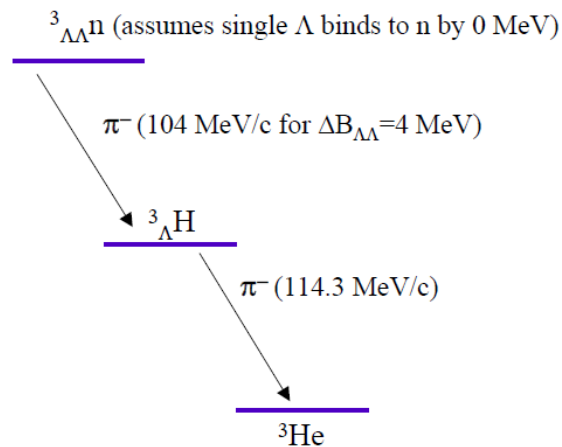

114 X 133 MeV Lines

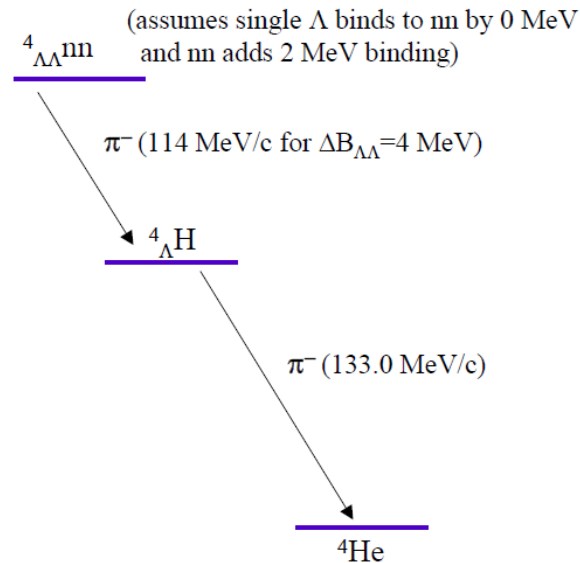

HYP2003

- Hybrid emulsion experiment @ JPARC may help to clarify this question

The background is a deep space scene. On the left, there's a large, vibrant nebula with shades of red, orange, and purple. The rest of the sky is filled with numerous stars of varying brightness, some with prominent diffraction spikes. In the center and right, there are several colorful, multi-colored structures that look like clusters of stars or small galaxies, rendered in a multi-color map style (red, green, blue, yellow). A semi-transparent dark grey rectangular box is overlaid on the center of the image, containing yellow text.

**...light neutral baryonic systems
may be full of surprises and
challenges**

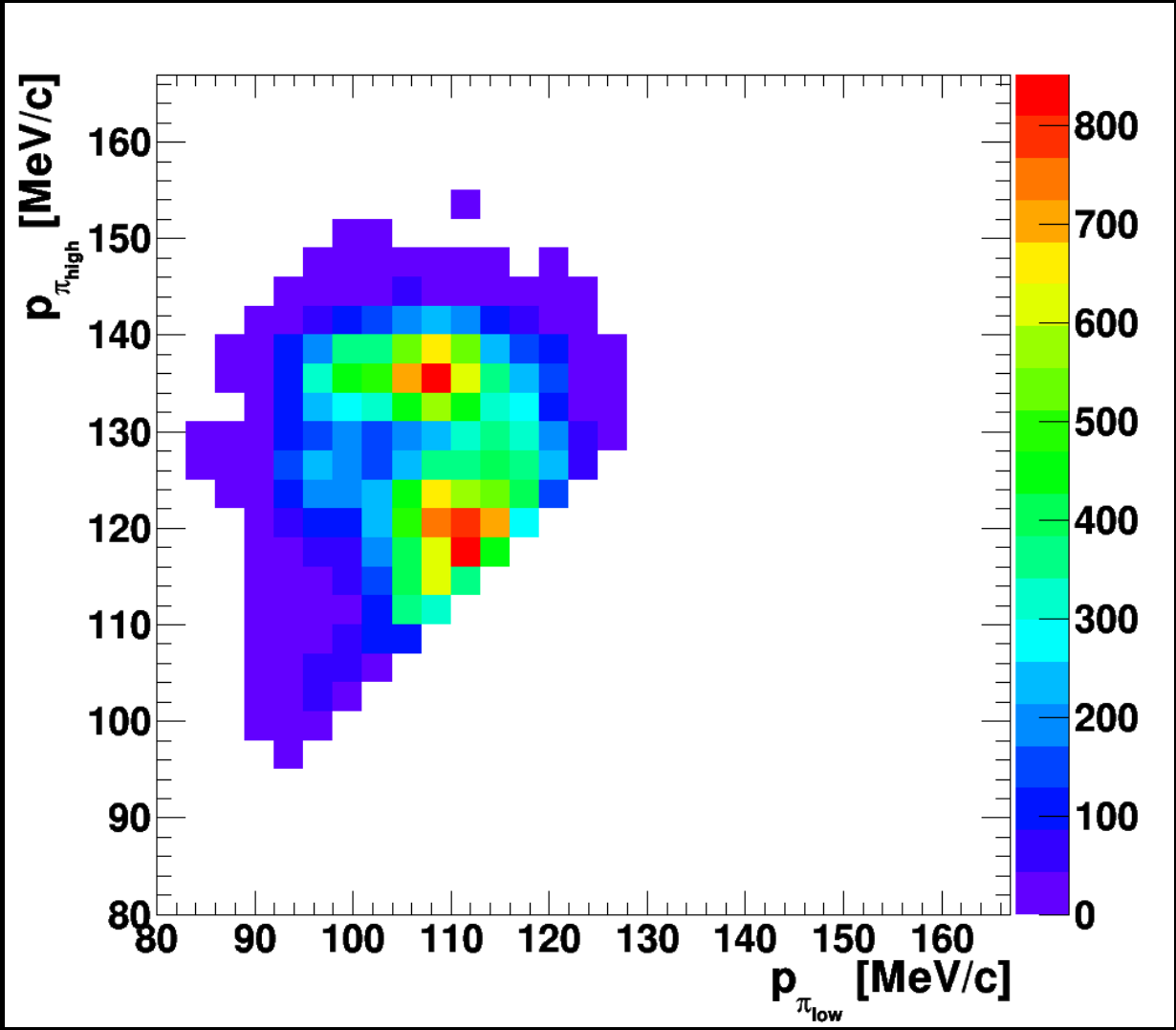

➤ $\Lambda\Lambda n$ possibly bound

PRL **110**, 012503 (2013)

PHYSICAL REVIEW LETTERS

week ending
4 JANUARY 2013

Strangeness – 2 Hypertriton

H. Garcilazo¹ and A. Valcarce²

¹*Escuela Superior de Física y Matemáticas, Instituto Politécnico Nacional, Edificio 9, 07738 México Distrito Federal, Mexico*

²*Departamento de Física Fundamental, Universidad de Salamanca, E-37008 Salamanca, Spain*

(Received 19 October 2012; published 4 January 2013)

We solve for the first time, the Faddeev equations for the bound state problem of the coupled $\Lambda\Lambda N - \Xi NN$ system to study whether or not a hypertriton with strangeness -2 may exist. We make use of the interactions obtained from a chiral quark model describing the low-energy observables of the two-baryon systems with strangeness 0 , -1 , and -2 and three-baryon systems with strangeness 0 and -1 . The $\Lambda\Lambda N$ system alone is unbound. However, when the full coupling to ΞNN is considered, the strangeness -2 three-baryon system with quantum numbers $(I, J^P) = (\frac{1}{2}, \frac{1}{2}^+)$ becomes bound, with a binding energy of about 0.5 MeV. This result is compatible with the nonexistence of a stable ${}^3_{\Lambda}\text{H}$ with isospin one.

➤ $nn\Lambda\Lambda$ may be bound (particularly if $nn\Lambda$ is bound)

- $S=0, I=1, L=0$
- No Pauli blocking
- Groundstate: $J^P=0^+$
- calculation still rather schematic

J.-M. Richard, Q. Wang, and Q. Zhao, *Phys. Rev. C* **91**, 014003 (2015)

➤ If $n\Lambda\Lambda$ and $nn\Lambda\Lambda$ are bound, they might help to understand the E906 puzzle

- The two-nucleon system consists of an isospin singlet state

$$T = 0: |np\rangle - |pn\rangle$$

and an isospin triplet

$$T = 1: T_3 = 1 \quad |nn\rangle \quad T_3 = 0 \quad \frac{1}{\sqrt{2}}(|np\rangle + |pn\rangle) \quad T_3 = -1 \quad |pp\rangle$$

- Simplified one-pion exchange gives rise to a term $\sim \tau_1 \cdot \tau_2$

$$\langle \tau_1 \cdot \tau_2 \rangle = \frac{1}{2} (\langle \tau^2 \rangle - \langle \tau_1^2 \rangle - \langle \tau_2^2 \rangle) = \frac{1}{2} [(\tau(\tau+1)) - (\tau_1(\tau_1+1))(\tau_2(\tau_2+1))]]$$

$$T = 0: \quad \langle \tau_1 \cdot \tau_2 \rangle = \frac{1}{2} \left[0(0+1) - \left(\frac{1}{2}\right)\left(\frac{1}{2}+1\right) - \left(\frac{1}{2}\right)\left(\frac{1}{2}+1\right) \right] = -\frac{3}{4}$$

$$T = 1: \quad \langle \tau_1 \cdot \tau_2 \rangle = \frac{1}{2} \left[1(1+1) - \left(\frac{1}{2}\right)\left(\frac{1}{2}+1\right) - \left(\frac{1}{2}\right)\left(\frac{1}{2}+1\right) \right] = +\frac{1}{4}$$

Scenario 1: Ξ^- Stopping & Fusion: $\Xi^- + {}^9\text{Be}$

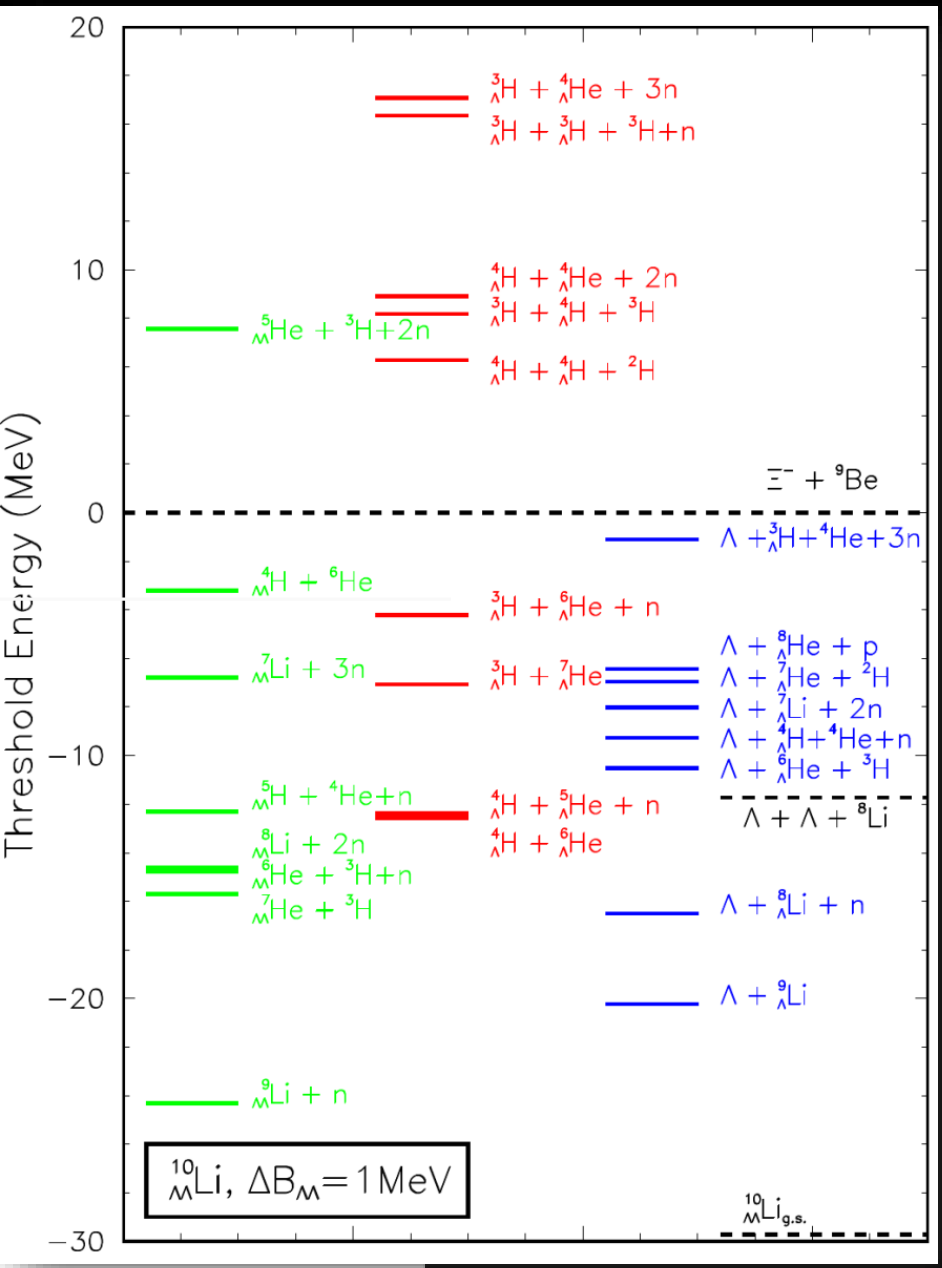
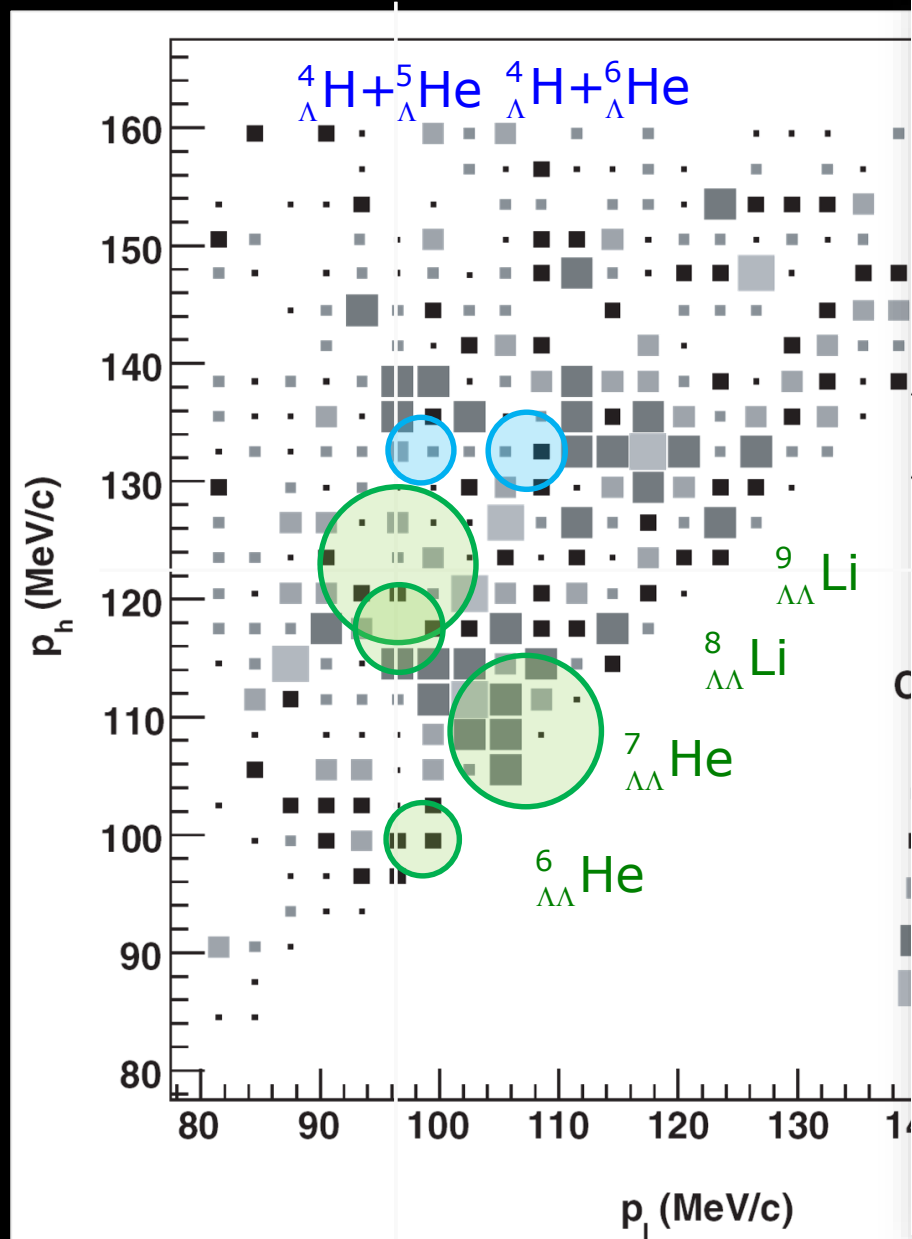

Proposal to Jefferson Lab PAC 45, July 2017

Determining the Unknown Λ - n Interaction by Investigating the Λ nn Resonance

Spokespersons:

L. Tang^{1,2*}, F. Garibaldi³, P.E.C. Markowitz⁴, S.N. Nakamura⁵, J.Reinhold⁴,
G.M. Urciuoli³

- missing mass experiment
- ${}^3\text{H}(e,e'K^+)(nn\Lambda)$
- will measure mass and width

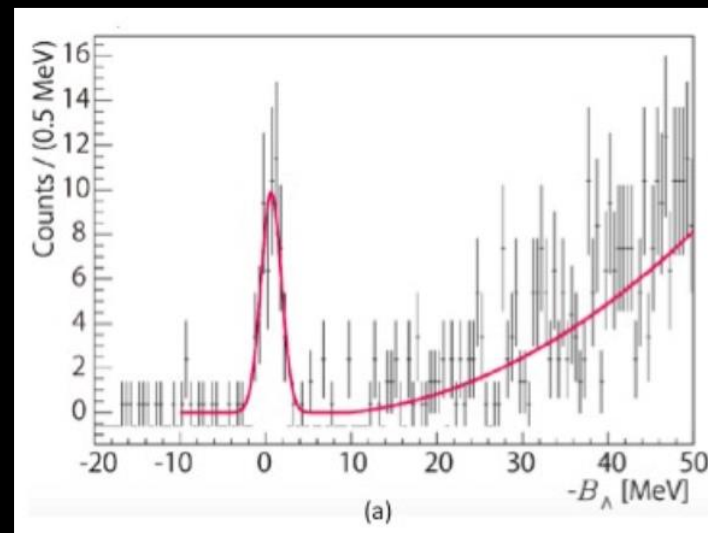
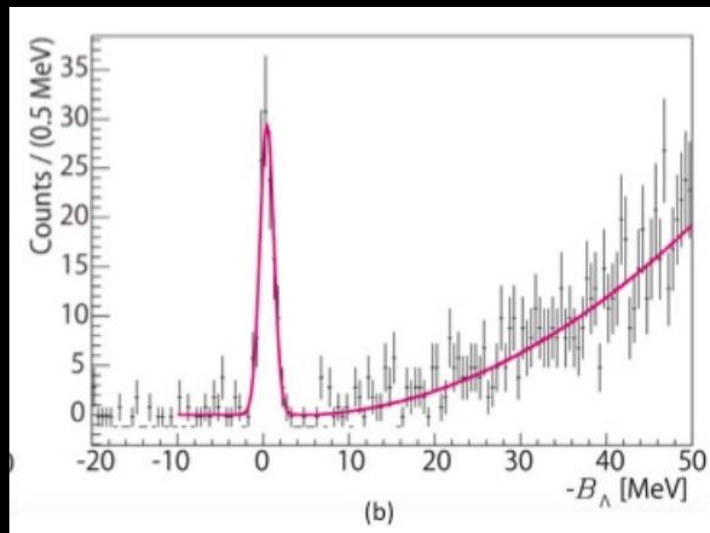

- approved , will run in November 2018

FRS+WASA for S447

See Talk by T. Saito on Friday

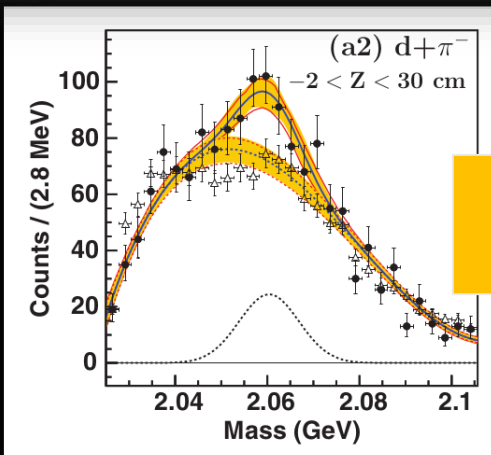
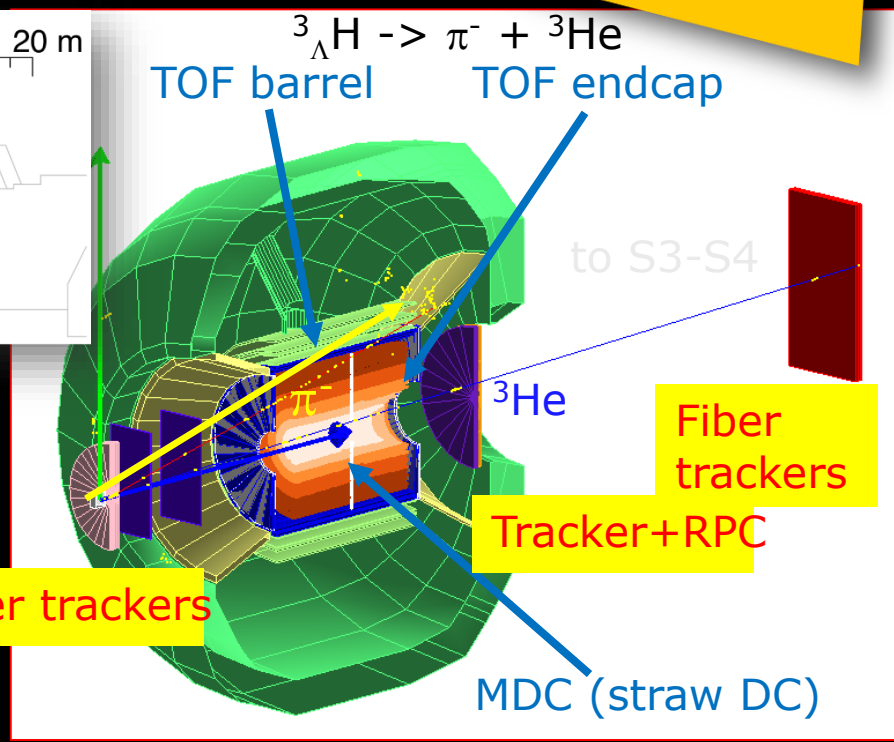
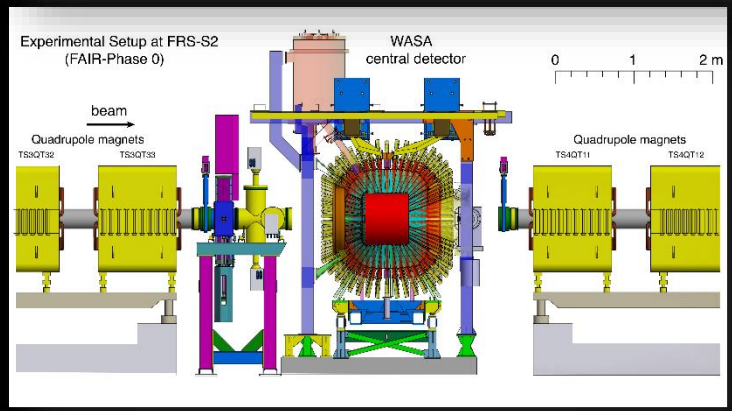
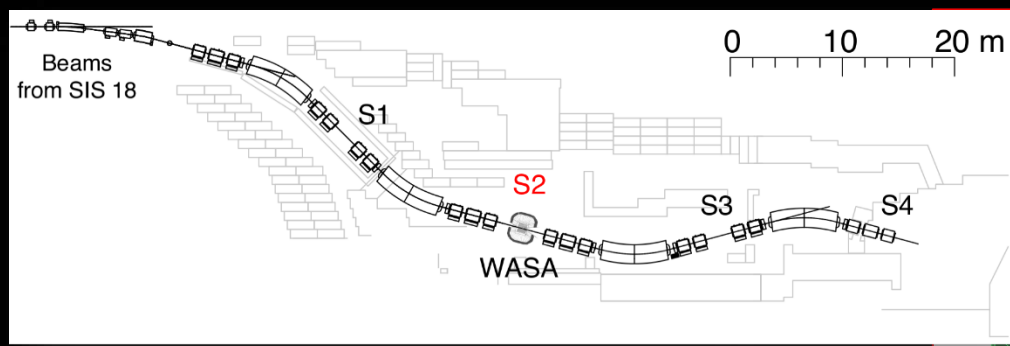

2019: for $d+\pi$
 2 times better mass resolution
 8 times better S/BG ratio

