

PANGEA – The PANda GERmanium Array

Marcell Steinen

Helmholtz-Institut Mainz

REIMEI Seminar

23.09.2020

This project has received funding from the European Union's Horizon 2020 research and innovation programme under grant agreement No. 824093.



Triple Detectors

- Common development with DEGAS (NuStar@FAIR)

Details on the detectors by Ivan next week!

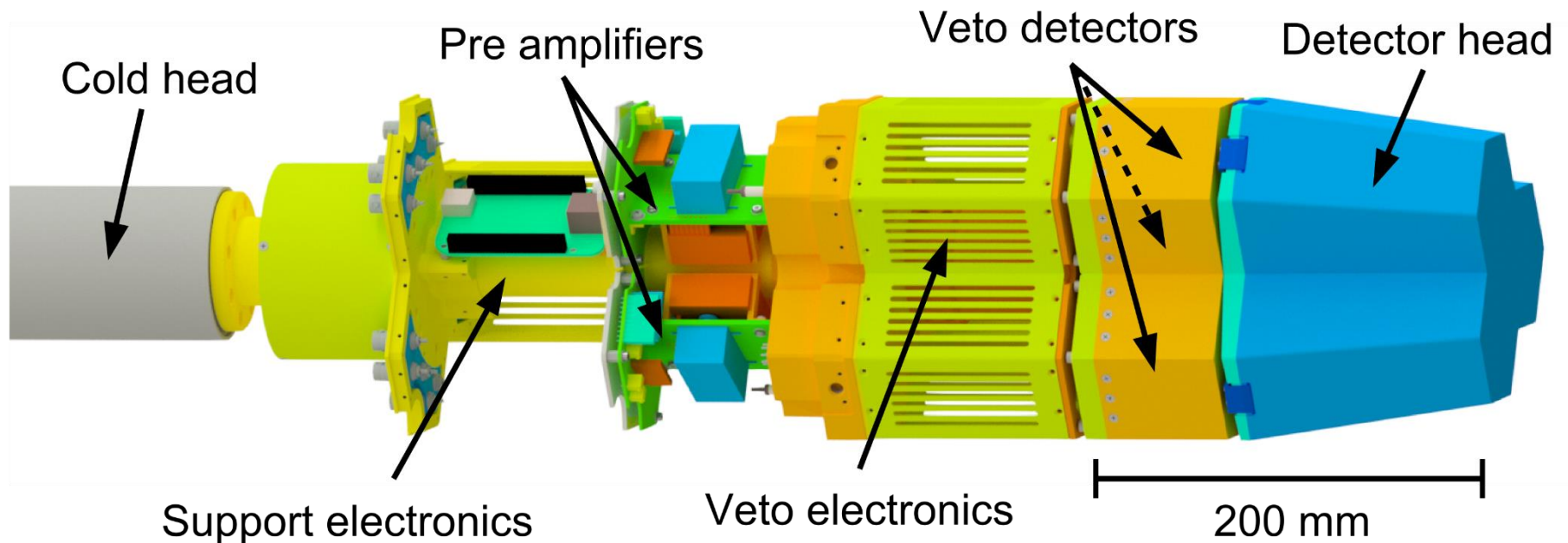

Outline

- Integration into PANDA
- Detector control system
- Digital DAQ system

PANGEA

- Study of Ξ^- hyperatoms and $\Lambda\Lambda$ hypernuclei
 - Energy range < 1 (10) MeV
- PANGEA integrated into PANDA
 - Limited space
 - Strong magnetic field
 - High hadronic background (≤ 4 MHz $\bar{p}C$)

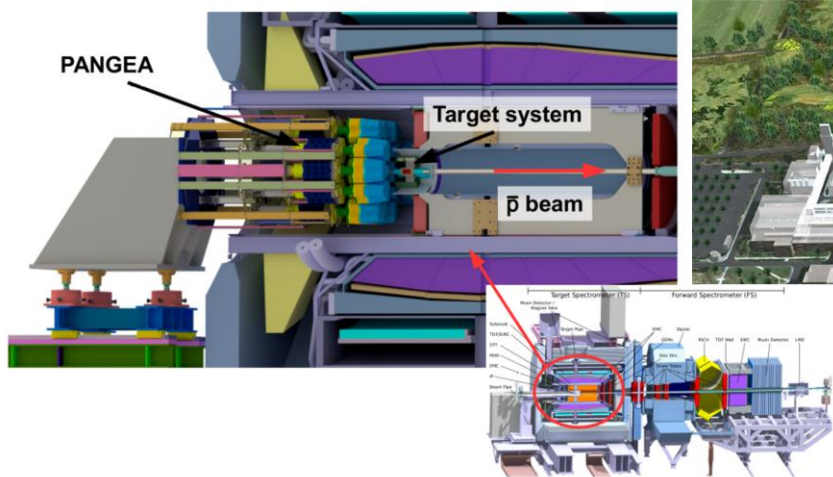
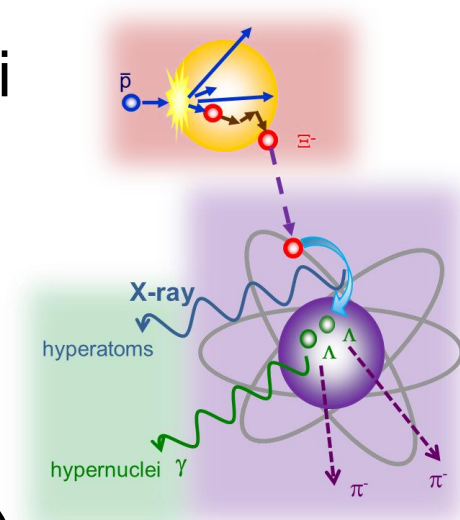

Integration - Optimization

- Fixed target experiment
 - Background peaking forward
- Hyperatoms/-nuclei at rest:
 - Isotropic distribution of γ
 - Shifted spherical geometry to even out background (R=40 cm, O = 20 cm)
- Placement options:
 - Tilted detectors (18 x 3)
 - Straight detectors (20 x 3)

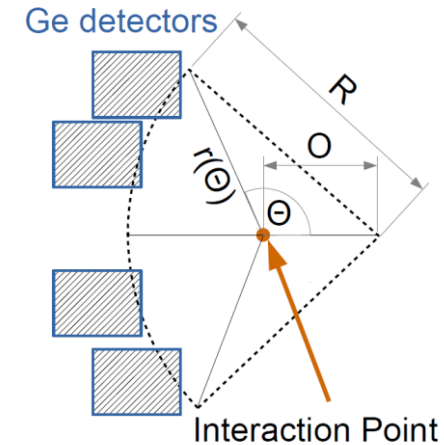

Isometric view

Frontal view

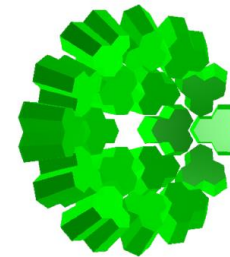

Spherical geometry

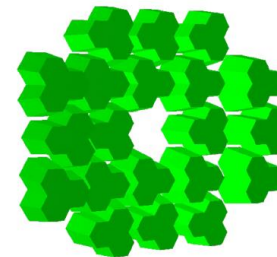
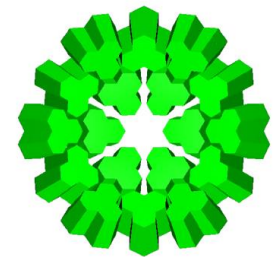

Column geometry

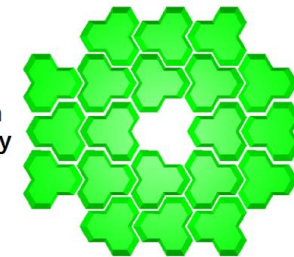

Integration - Efficiency

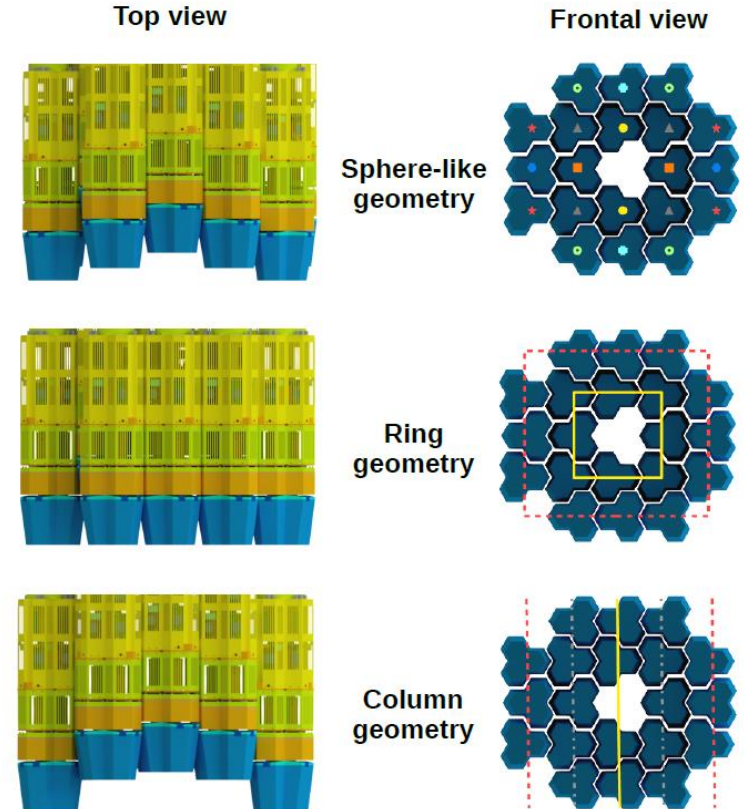
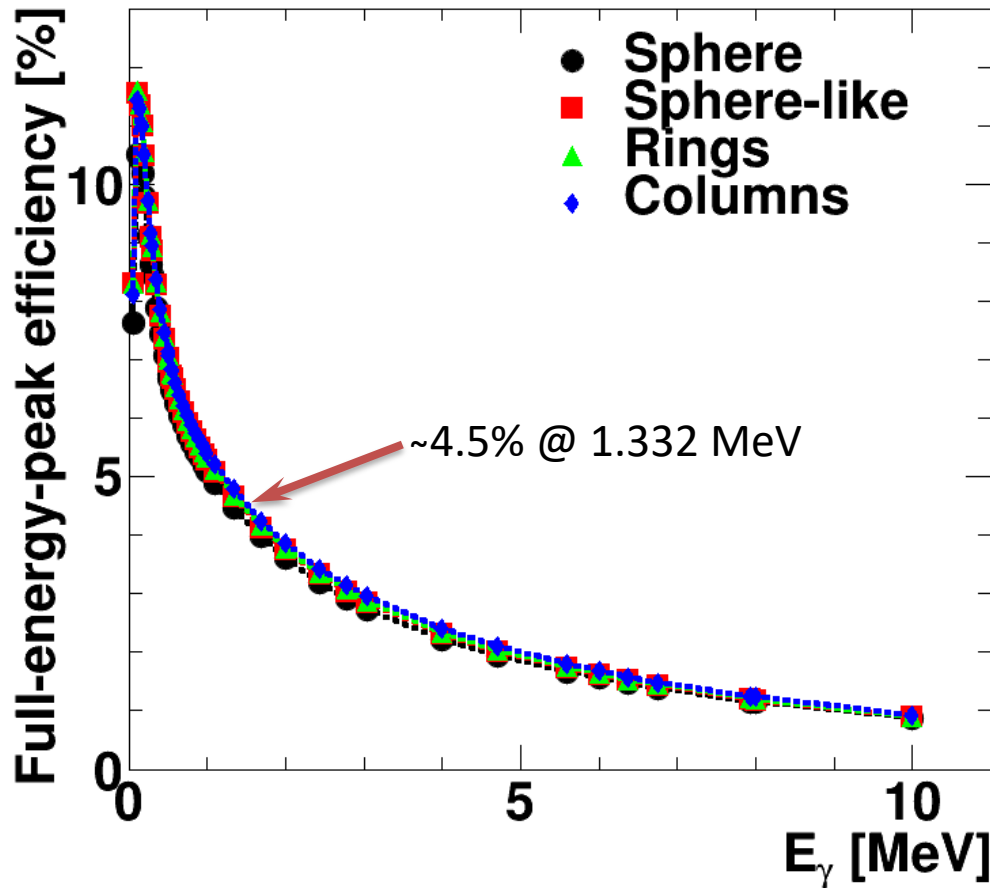

Absorption in target system included!

Mechanical Integration

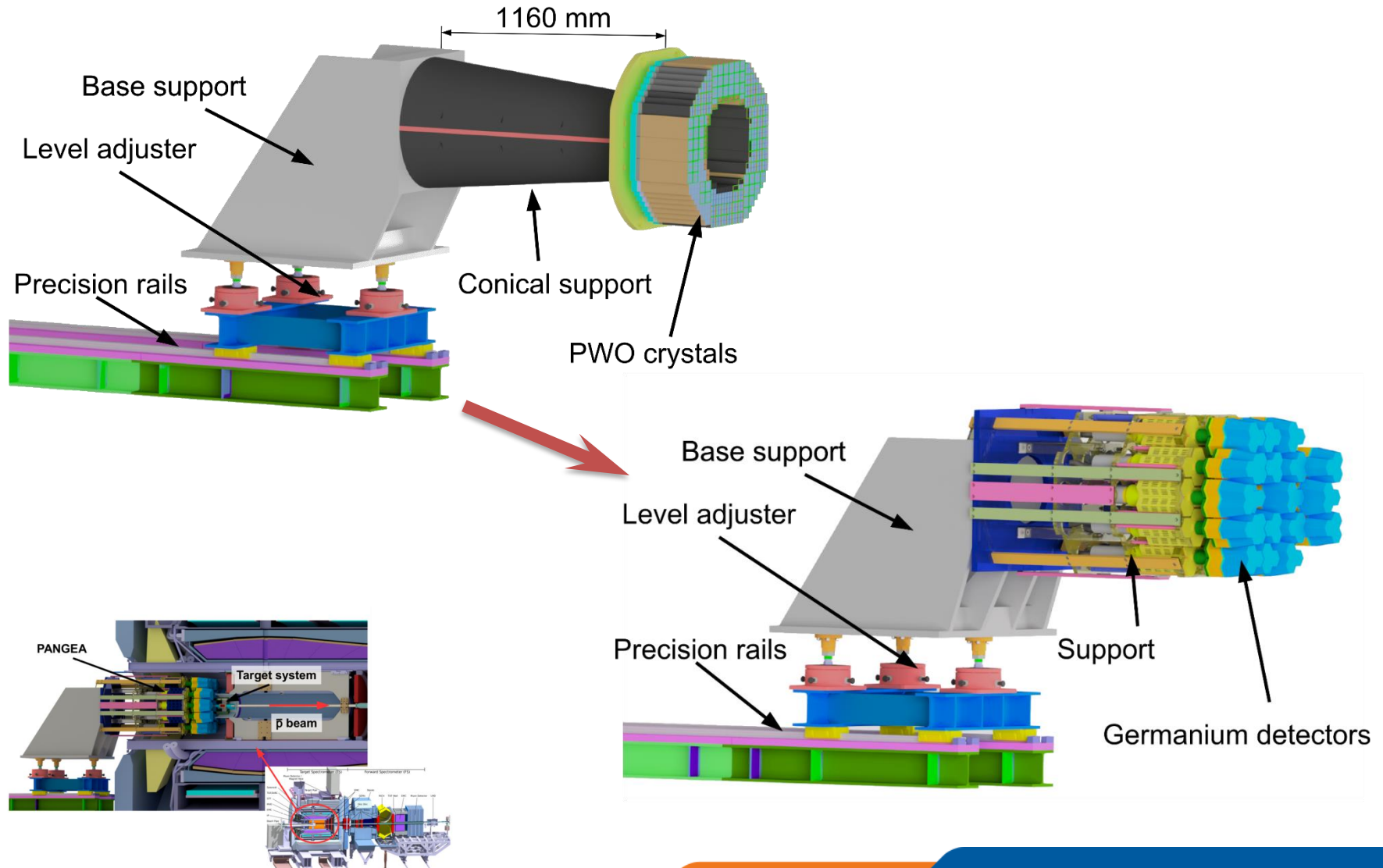

Mechanical Integration

- Stability tested in simulations
- Flexible setup allows modifications of geometries

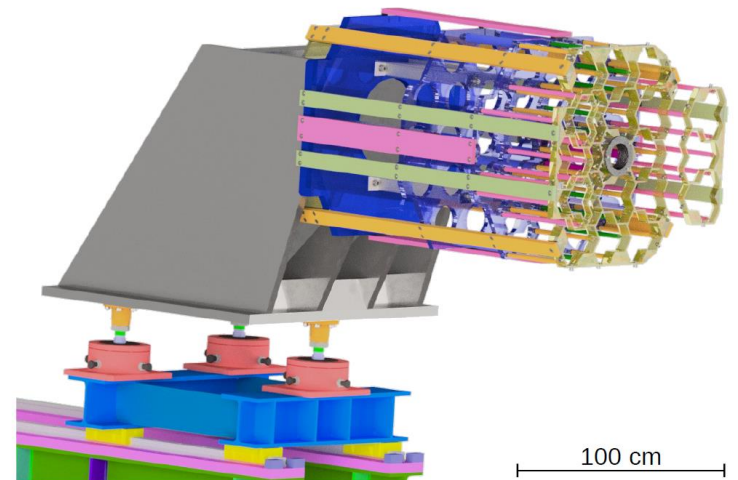
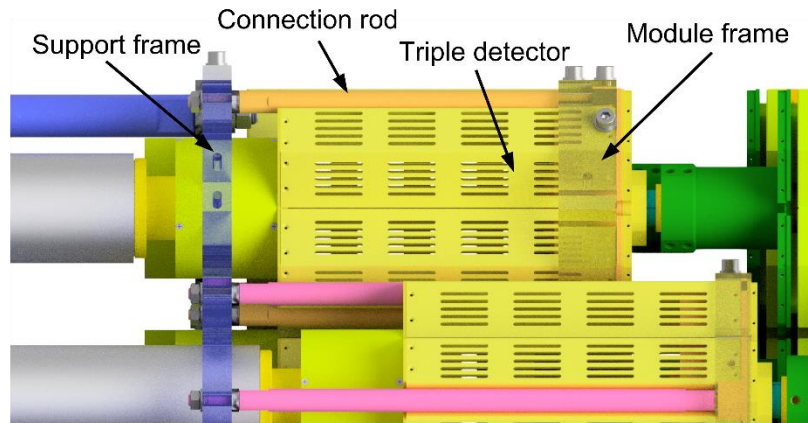
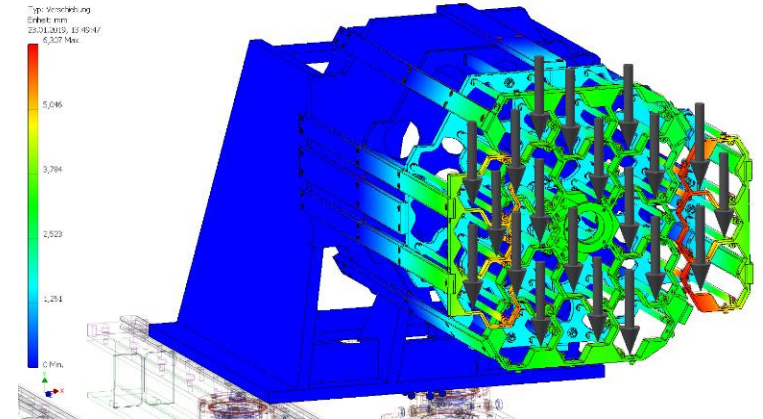

Transformation of setup

- Quick transformation of setups required
- Modules simplify accessibility and maintainability of the germanium detectors

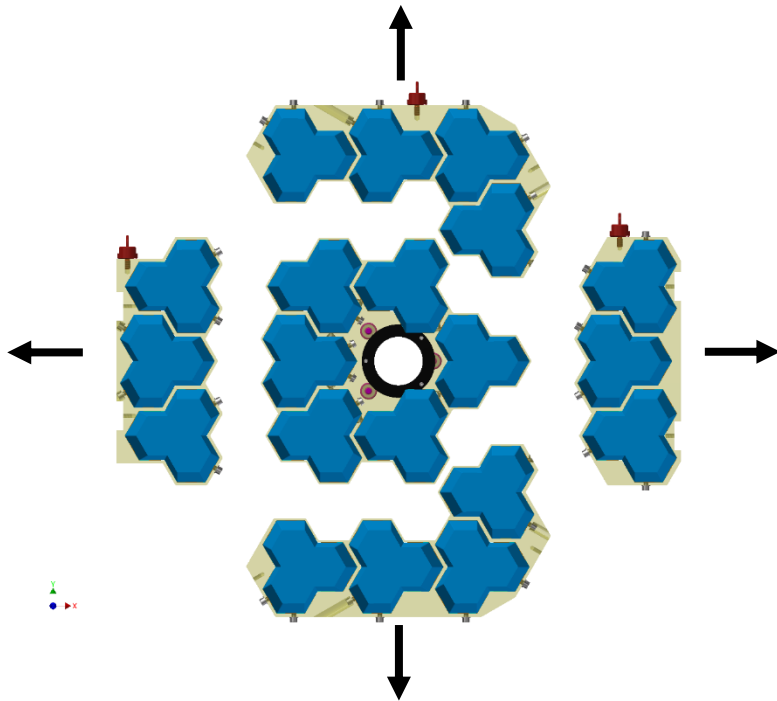
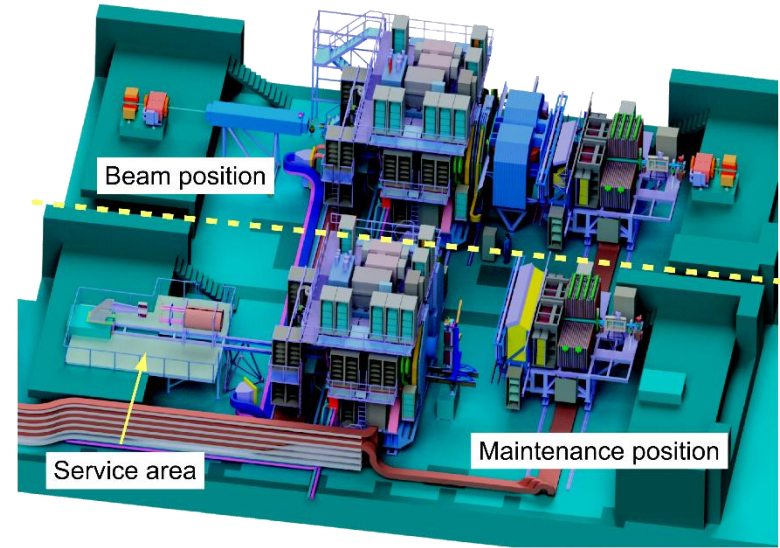

Process	Time requirement
Move PANDA to maintenance position	1 week
Remove EMC endcap	1-2 weeks
Detach STT and remove MVD and beam pipe (central frame)	2-3 weeks
Install target system and beam pipe (central frame), reattach STT	1 week
Build up PANGEA	1 week
Move and calibrate hyperatomic/hypernuclear setup into target spectrometer	1 week
Move PANDA to beam position	1 week
Cool down magnet, pumping, final calibration and commissioning	2 weeks
Total	10-12 weeks

DCS - PANDA

- PANDA uses EPICS
- Distributed control system

EPICS

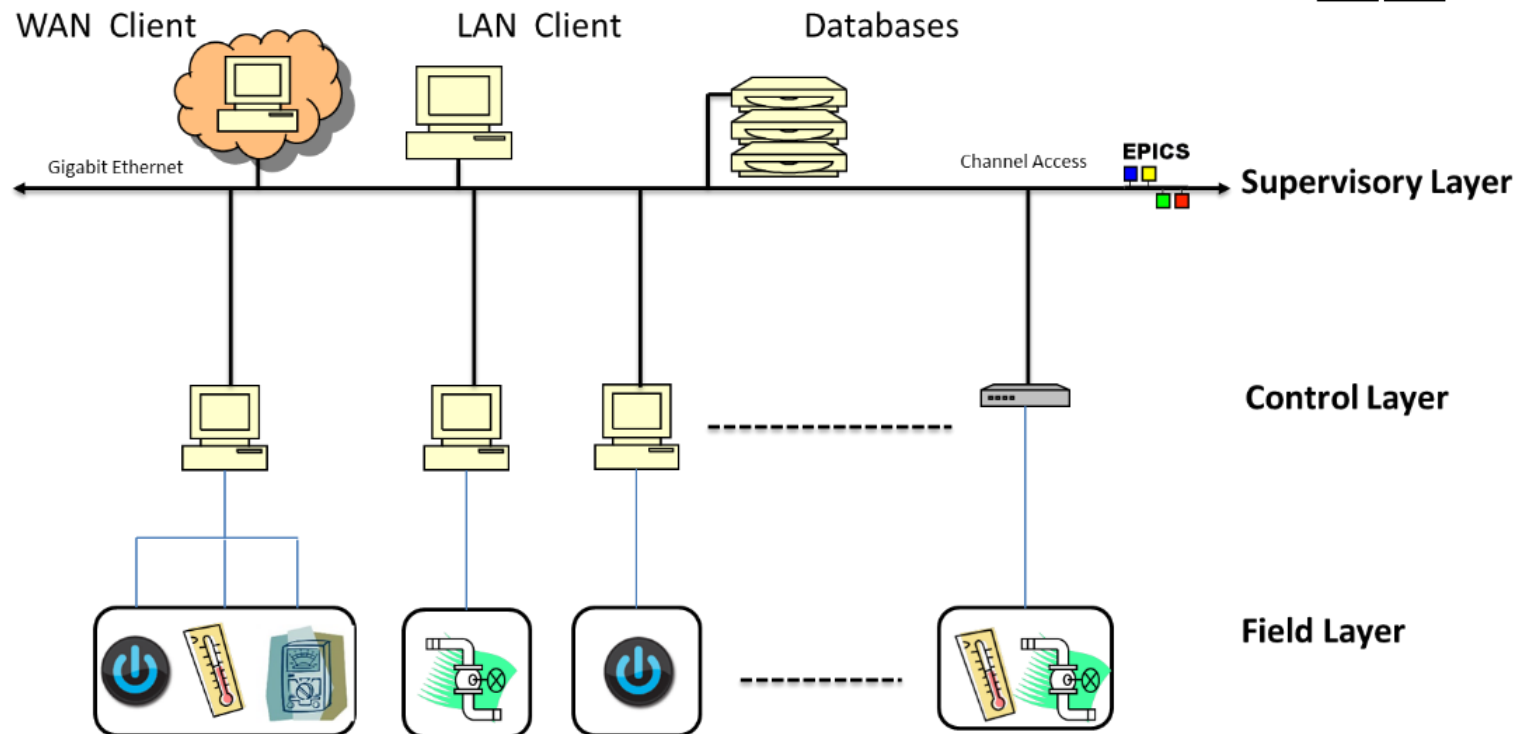
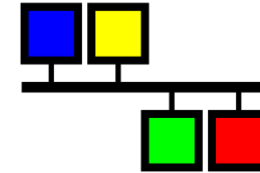

DCS - PANGEA

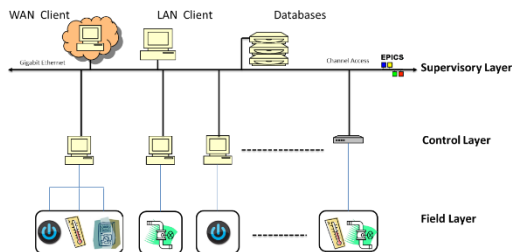

- DCS subnet for PANGEA
- IOC for each individual triple detector

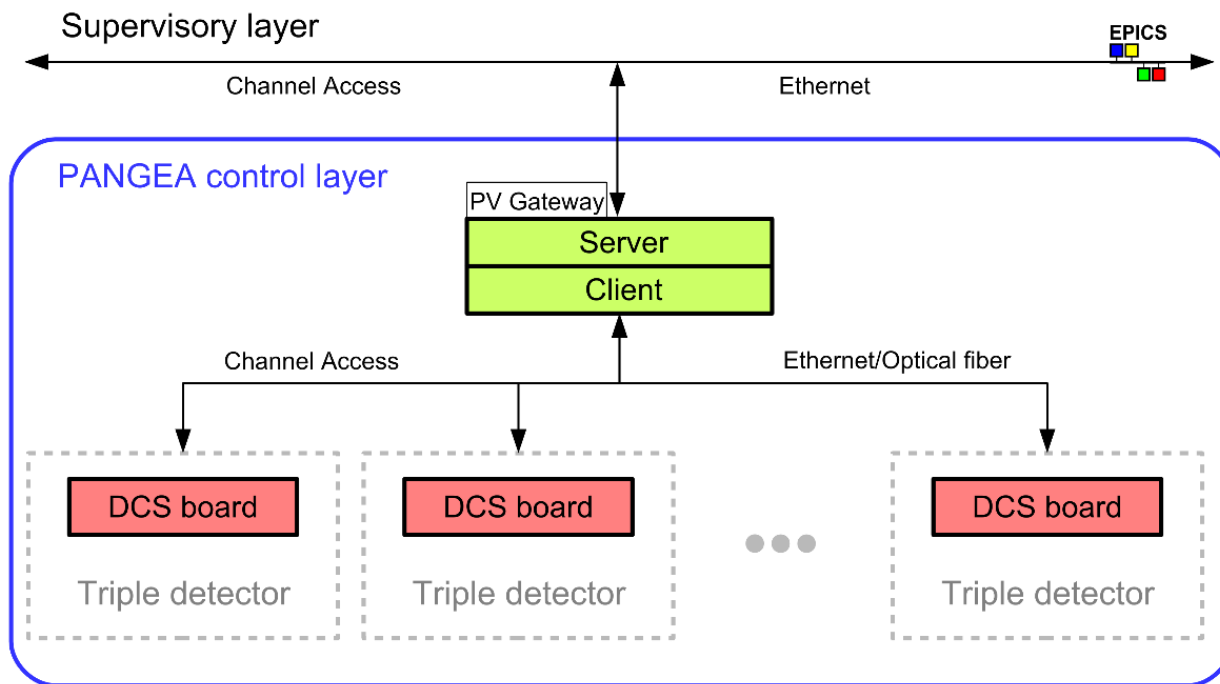

DCS - PANGEA detectors

- DCS Board
 - Control and monitoring
 - Prototyping with BBB
 - Common FAIR development of radiation hard board (RISC-V under investigation)

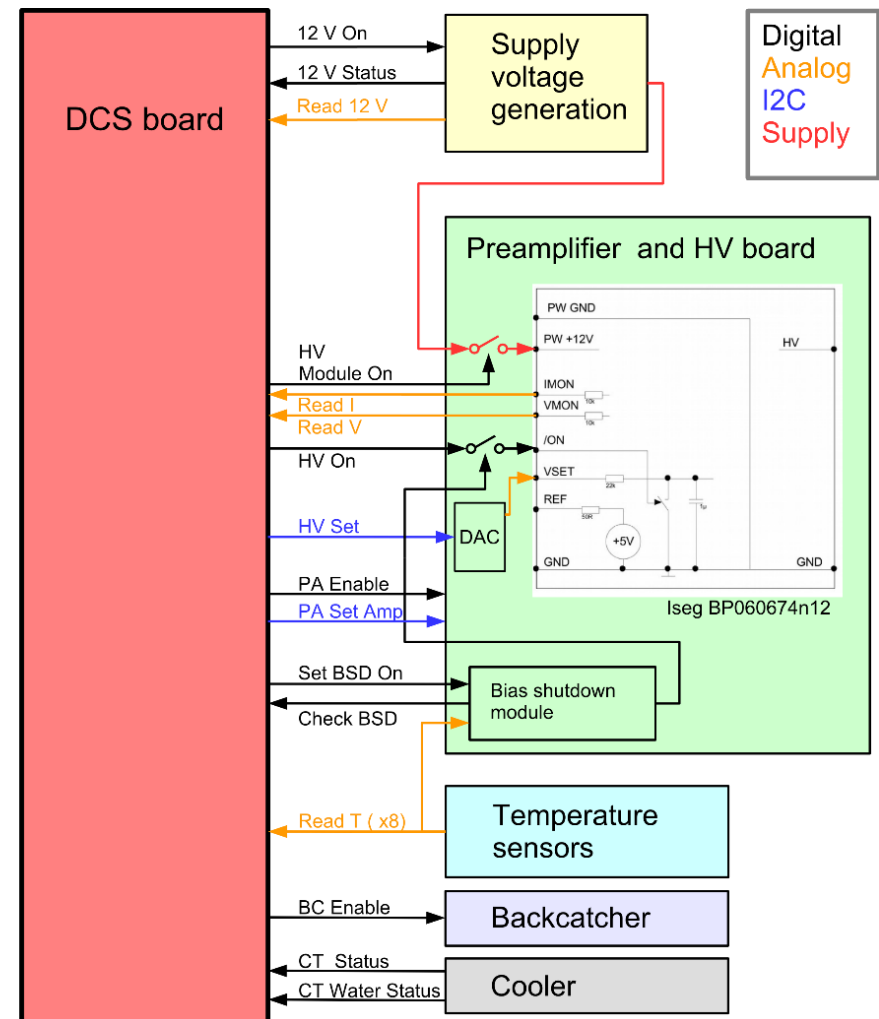

DAQ of PANGEA

- Digital readout
- EMC digitizers suitable:
 - 14 bit
 - 80 MSa/s
 - 64 channels
- single module for full PANGEA
- Adjustable firmware
- Energy extraction implementable in firmware

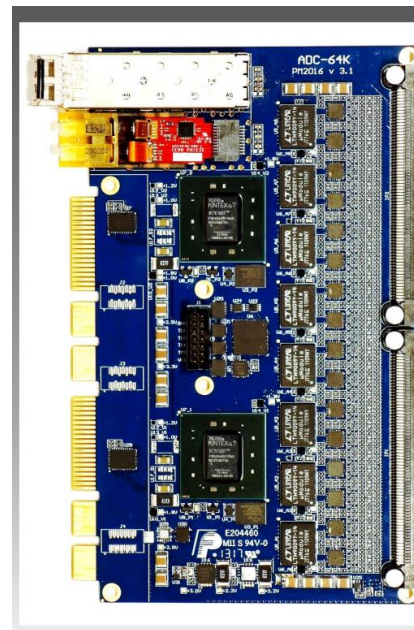
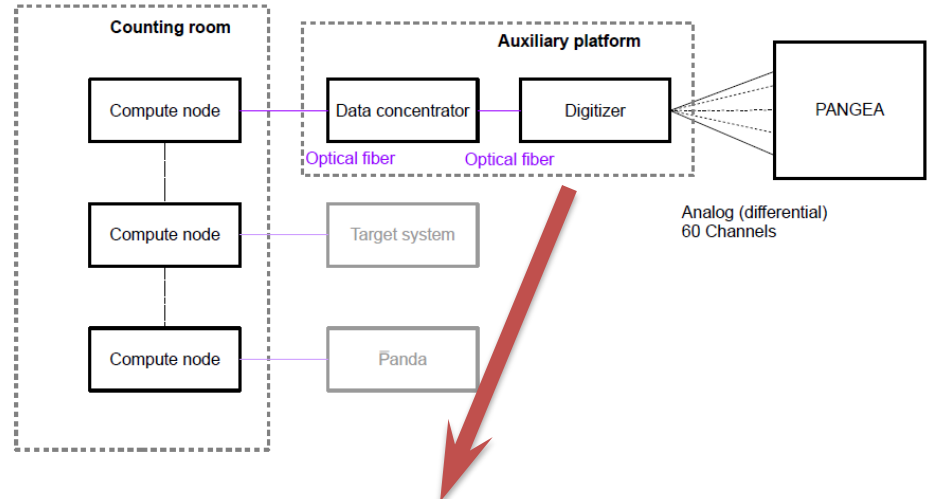

ADC Model	ADC_64K EMC-FE	ADC_64K SHASHLYK
No. of channels	32 (64)	64
Sampling rate	80 MSPS	125 MSPS
Input coupling	AC, DC, positive, negative, diff	
Resolution ENOB	14-bit (dual range)	11.5-bit
Input Connector	Samtec	
Baseline	0V	
Input range (dual)	$\pm 2.2V, \pm 140 mV$	$\pm 1.0V$
Noise (rms)	100uV	
Data retention/ch.	25us	
Input filter	Active-filter/Amplifier	
Interface	Optical, SFP, LC-type, 2 Gbit/s	
Power	18W	21W
Feature extraction:		

Pawel Marciniewski, TWEPP-2017

Moving window deconvolution

- Original signal with exp.

Decay

$$f(t) = \begin{cases} A \exp(-\frac{t}{\tau}) & t \geq 0 \\ 0 & t < 0 \end{cases}$$

- Deconvolution

$$\begin{aligned} A[n] &= x[n] + \frac{1}{\tau} \sum_{k=-\infty}^{n-1} x[k] \\ &= x[n] - \left(1 - \frac{1}{\tau}\right) x[n-1] + A[n-1] \end{aligned}$$

- Shortening of the signal (high rate)

$$\begin{aligned} MWD_M[n] &= \nabla_M A[n] \\ &= A[n] - A[n-M] \end{aligned}$$

- Low pass (trapezoidal) filter

$$\begin{aligned} MA_L[n] &= \frac{1}{L} \sum_{k=n-M}^{n-1} MWD_M[k] \\ &= MA_L[n-1] + \frac{1}{L} (MWD_M[n] - MWD_M[n-L]) \end{aligned}$$

- Applicable in FPGA

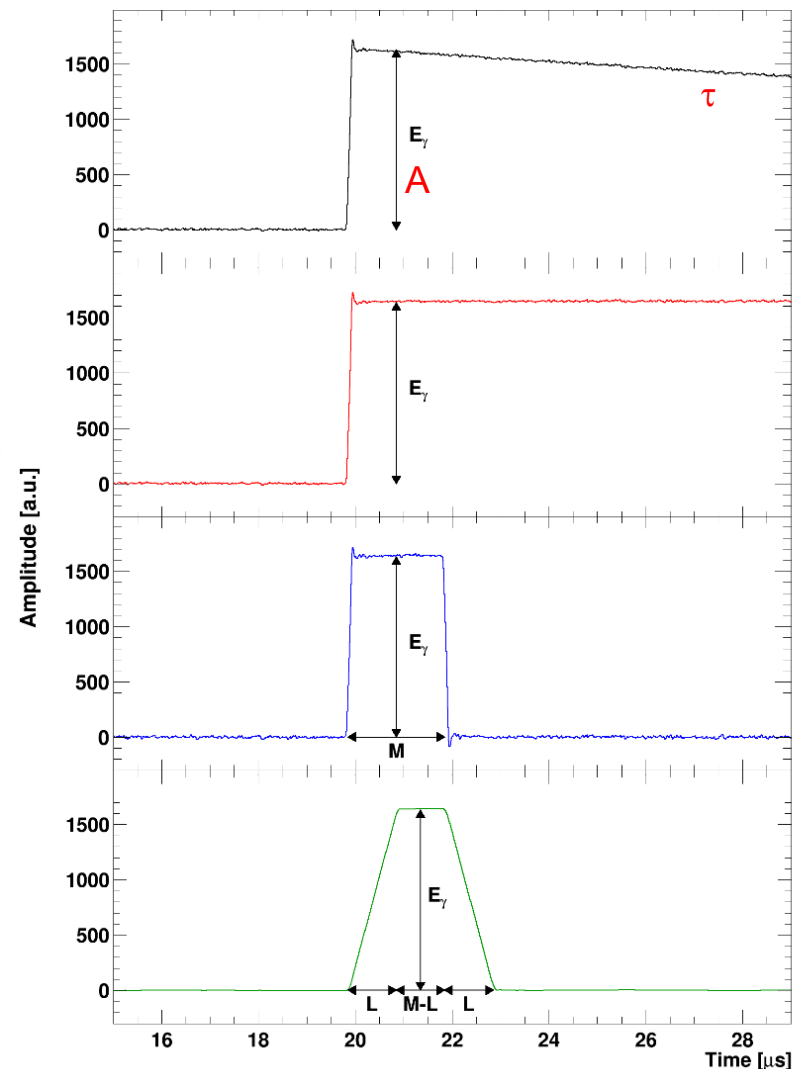

Pulse shape analysis

- More information entangled in signal
- Digitization allows to analysis the full signal
 - Study of the rising edge

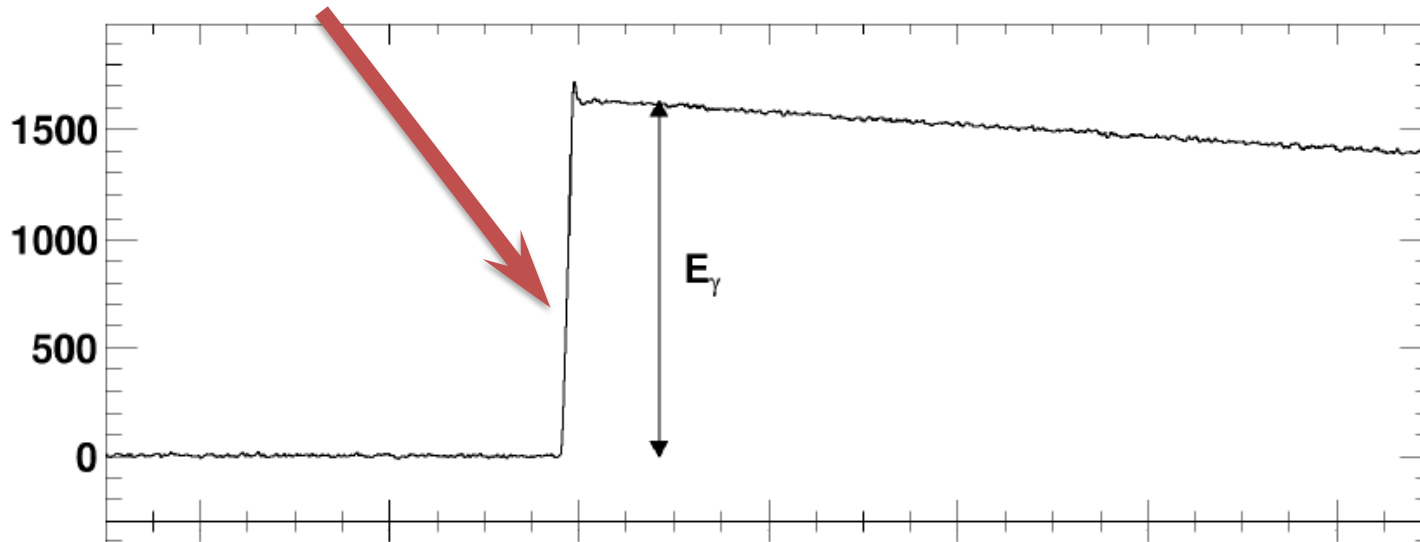

- Recover effects of magnetic fields
- Recover radiation damage

HPGe in Magnetic field

- Increased rise time by curling of charge carriers within the crystal
- Broadened and shifted Co-60 line

fADC: Struck SIS3300, 8 chan.,
100 MSa/s, 12 bit

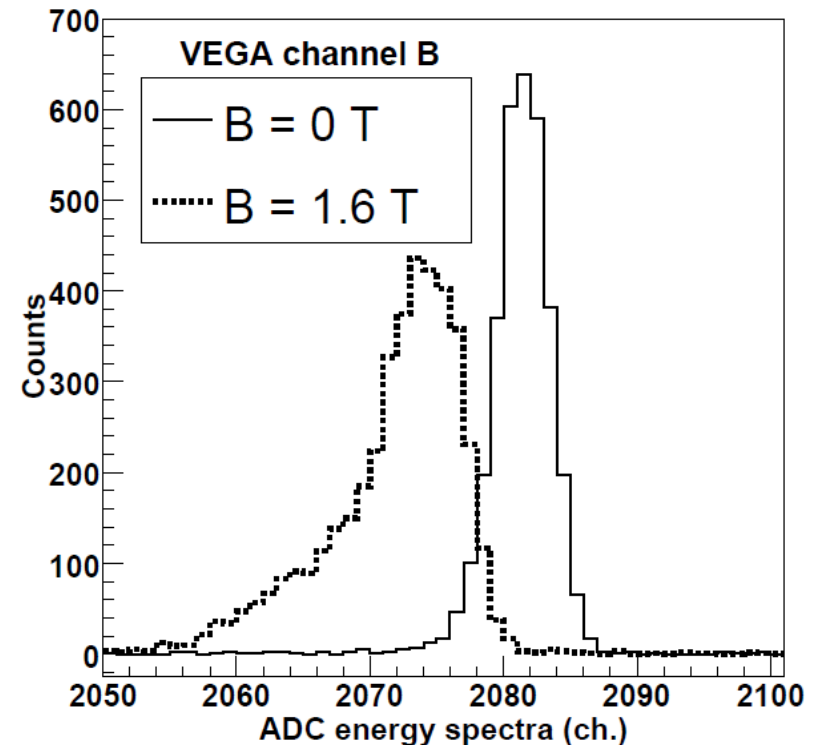
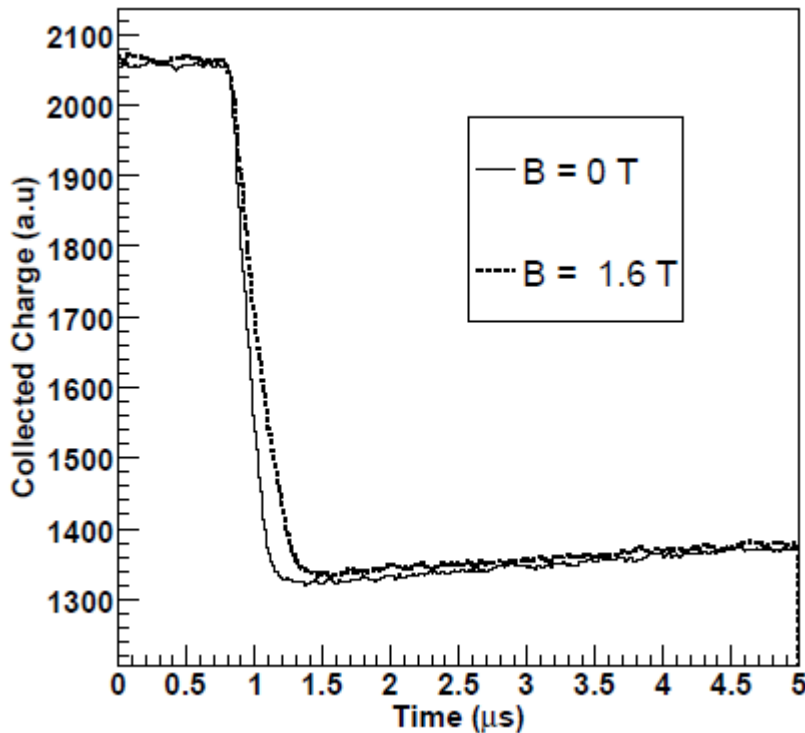

A. Sanchez Lorente et al. , NIM A 573.3 (2007)

Rise time dependance

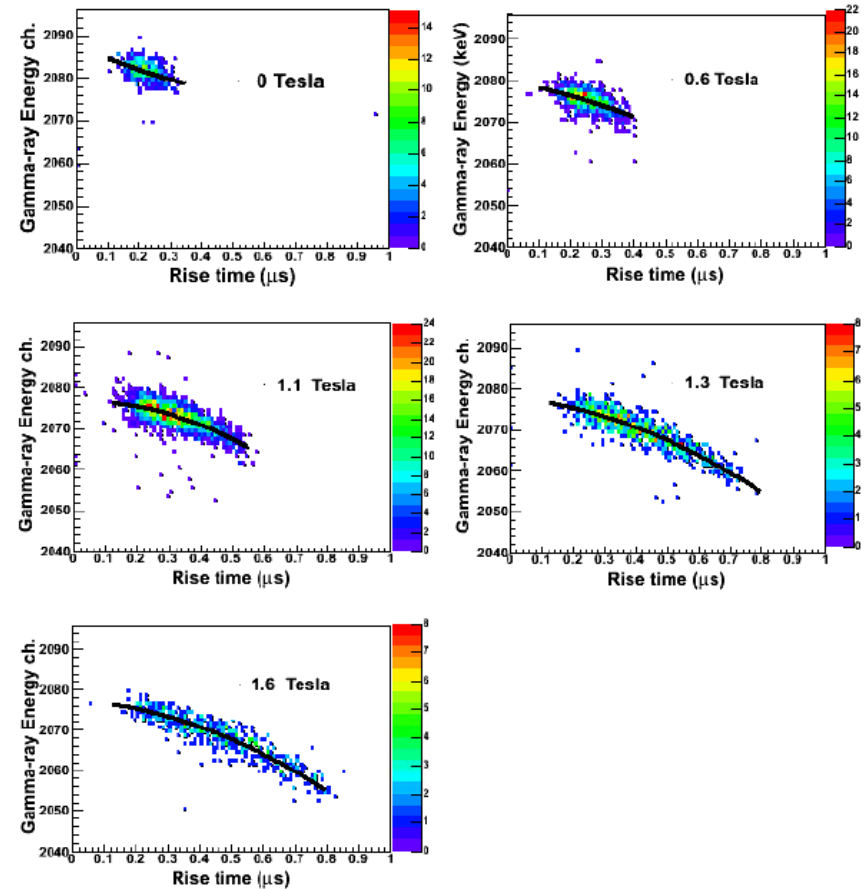
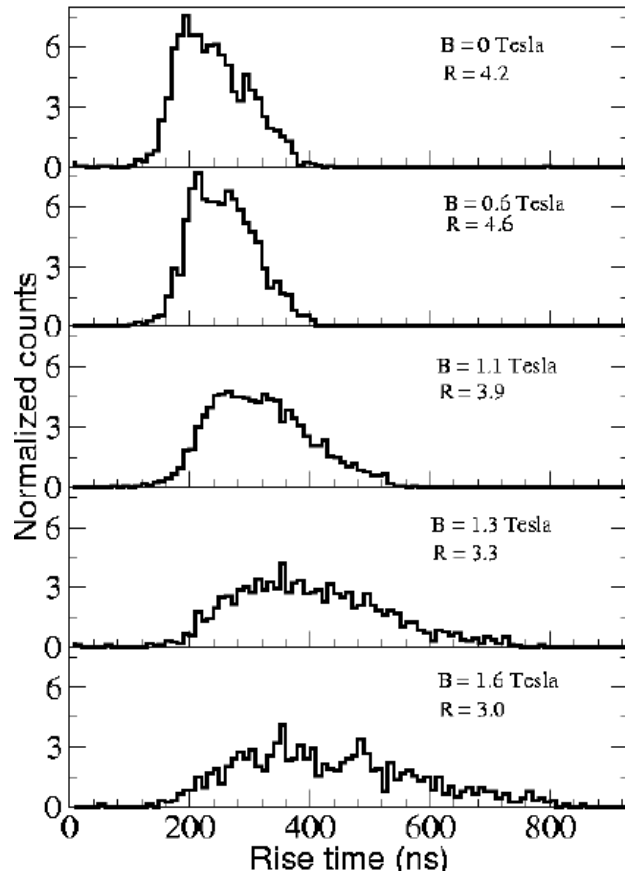

A. Sanchez Lorente et al. , NIM A 573.3 (2007)

Rise time correction

- Fit of data and event-wise correction

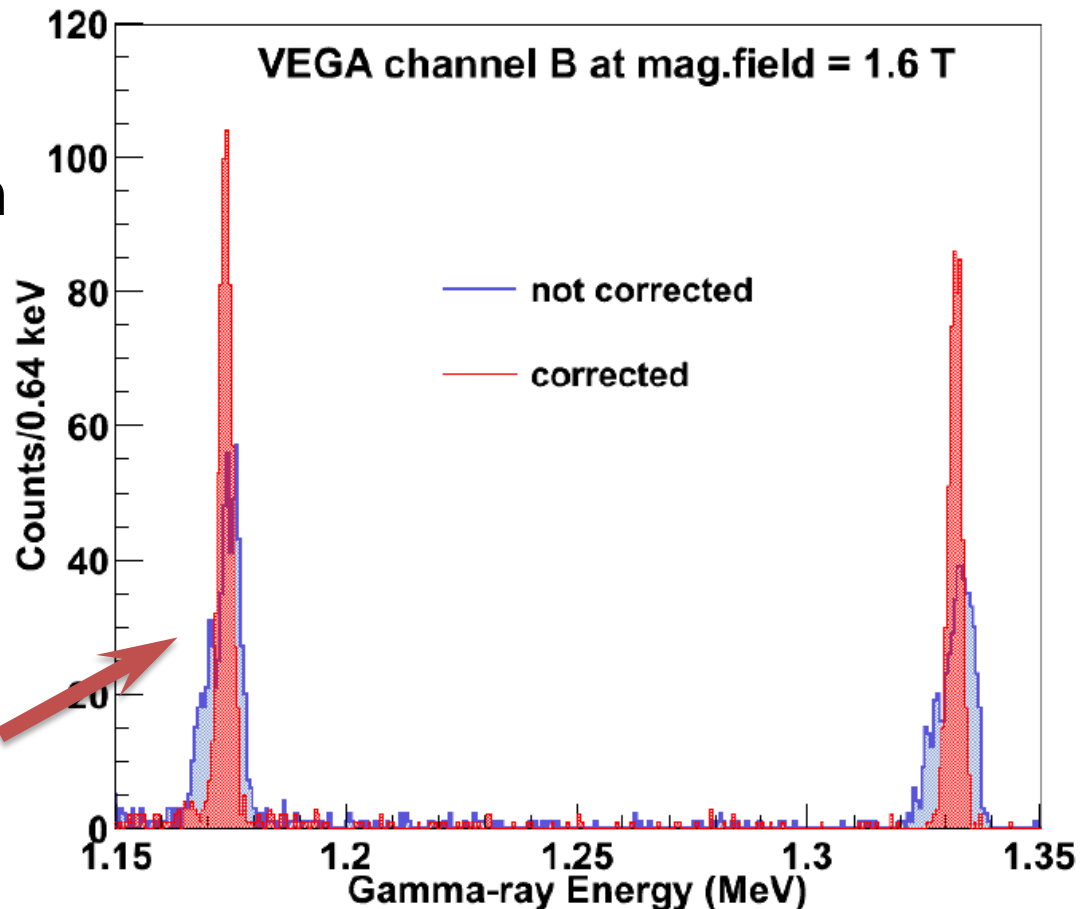
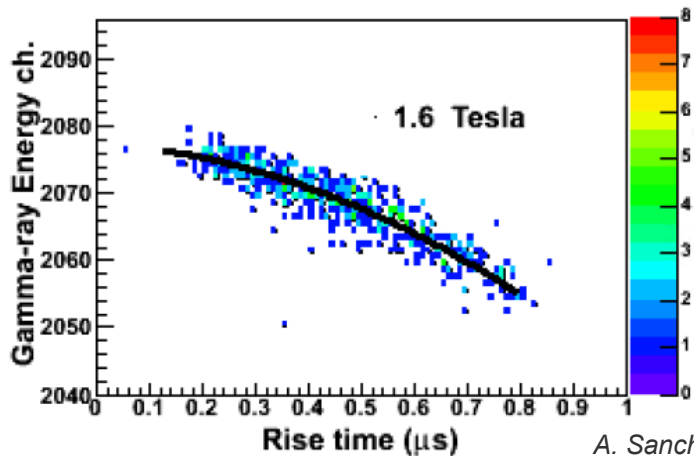

A. Sanchez Lorente et al. , NIM A 573.3 (2007)

$\Xi^- - {}^{208}\text{Pb}$ - Online calibration

$\Xi^- - {}^{208}\text{Pb}$ Hyperatom

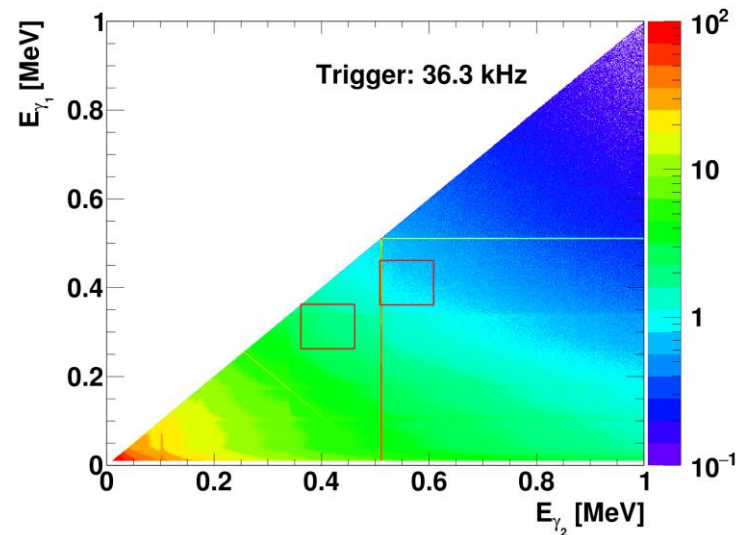
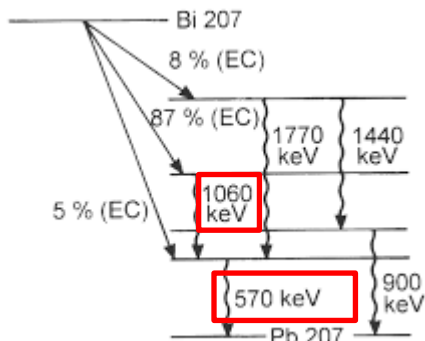
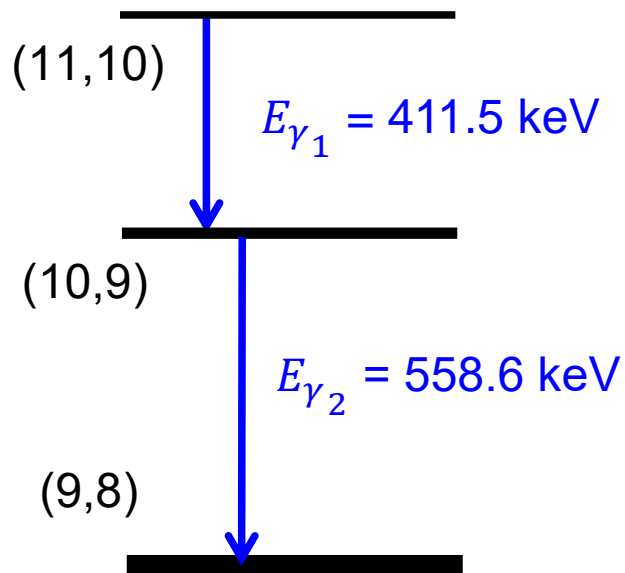

$0^+ \text{ Ru-106 } 373.59 \text{ d } 0.0$
 $\beta^- (100\%) 39.4 \text{ keV} \rightarrow 1^+ \text{ Rh-106 } 29.8 \text{ s } 0.0$

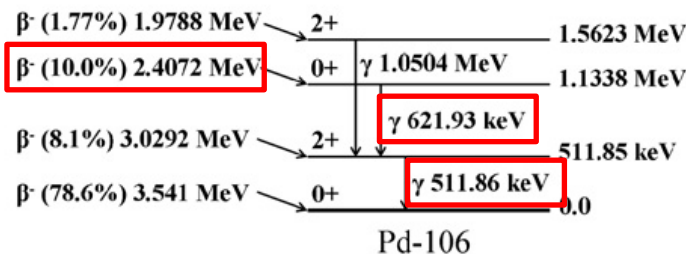

M.C: Fuss et al. Applied Radiation and Isotopes 69 (2011)

Magnetic fields results

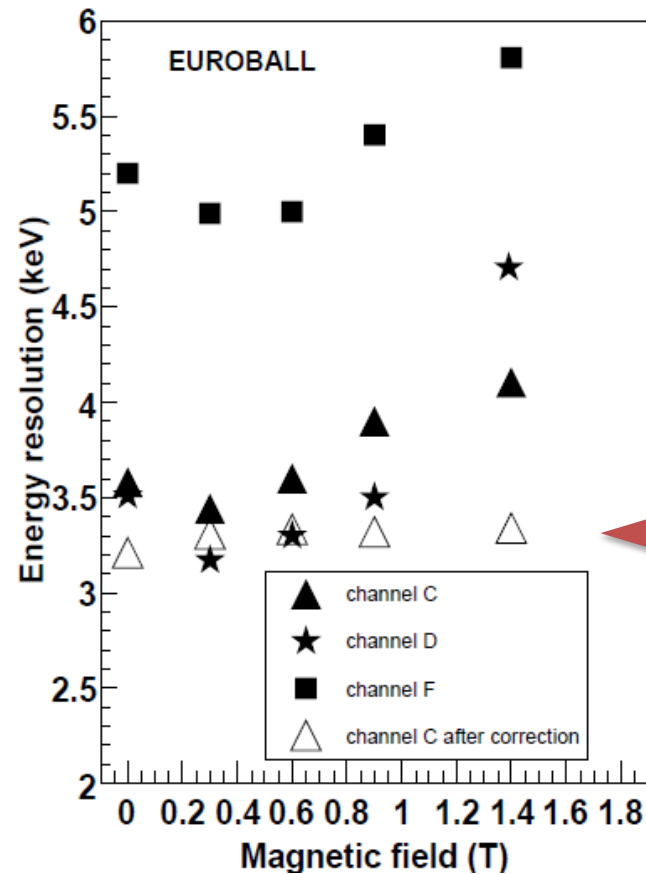
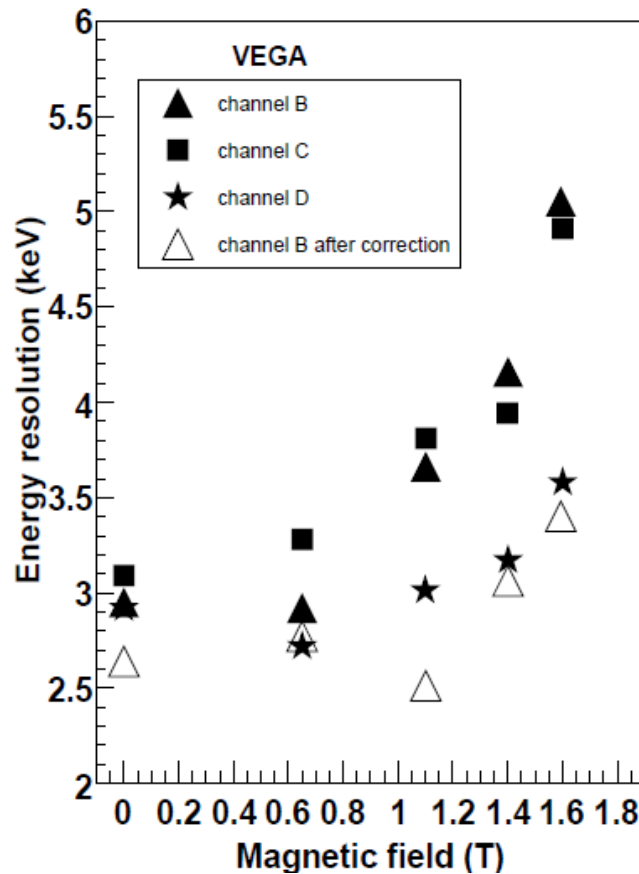

- Correction allows recovery

A. Sanchez Lorente et al. , NIM A 573.3 (2007)

Radiation damage

- Neutron irradiation:
 - Decrease of HPGe performance
 - Trapping of charge carriers (holes)

→ n-type more resistant

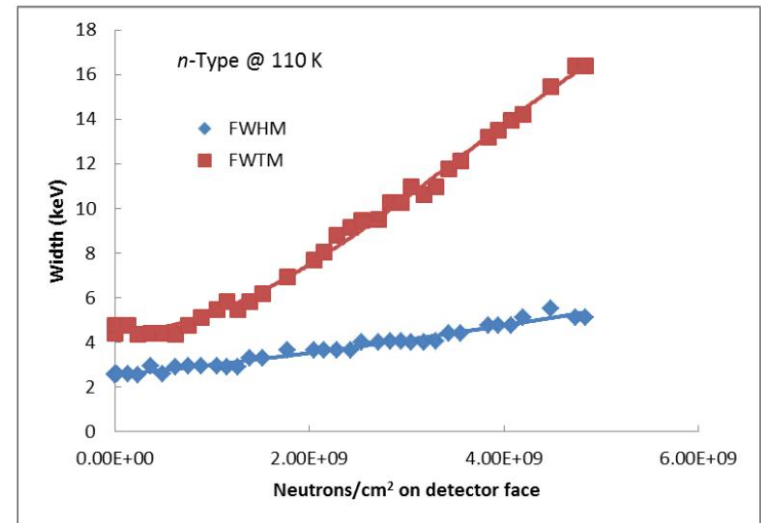
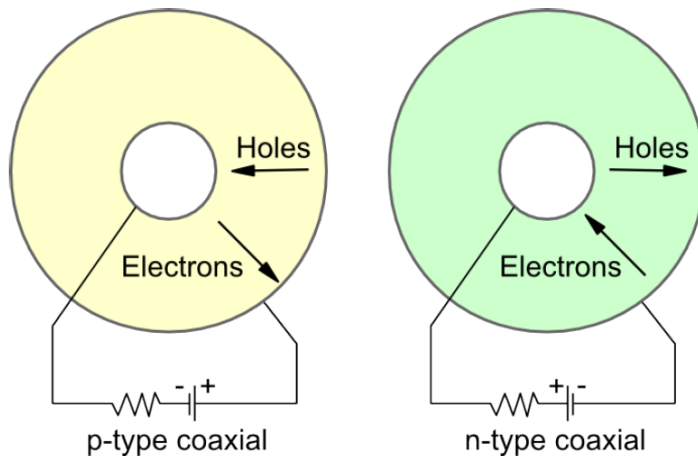

E. H. Seabury et al. 2013 IEEE Nuclear Science Symposium and Medical Imaging Conference (2013 NSS/MIC), Seoul, 2013,

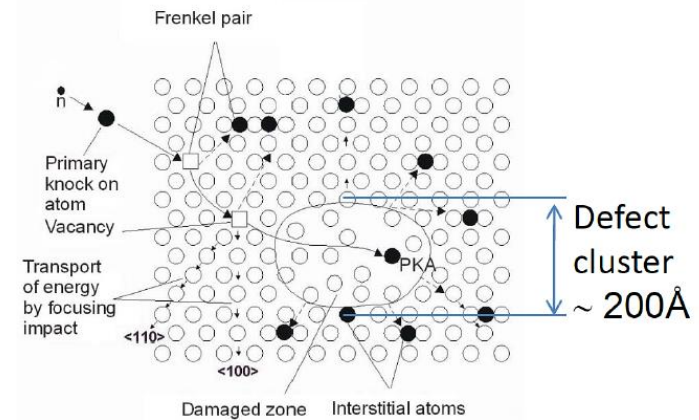

PANGEA - radiation damage

- \bar{P} ANDA: crystals with up to $1 \cdot 10^{10}$ n/cm² within experiment (180 days)
- Test beam @ COSY (FZ Jülich, Germany)
- E.-m.-cooled prototype with 1 EUROBALL crystal (n-Type)
 - Neutrons produced in $p(2.78 \text{ GeV}/c)+C$: similar to $\bar{p}+C$ @ \bar{P} ANDA
 - $5.6 \cdot 10^{10}$ n/cm² in 5.5 days → 94 days of \bar{P} ANDA

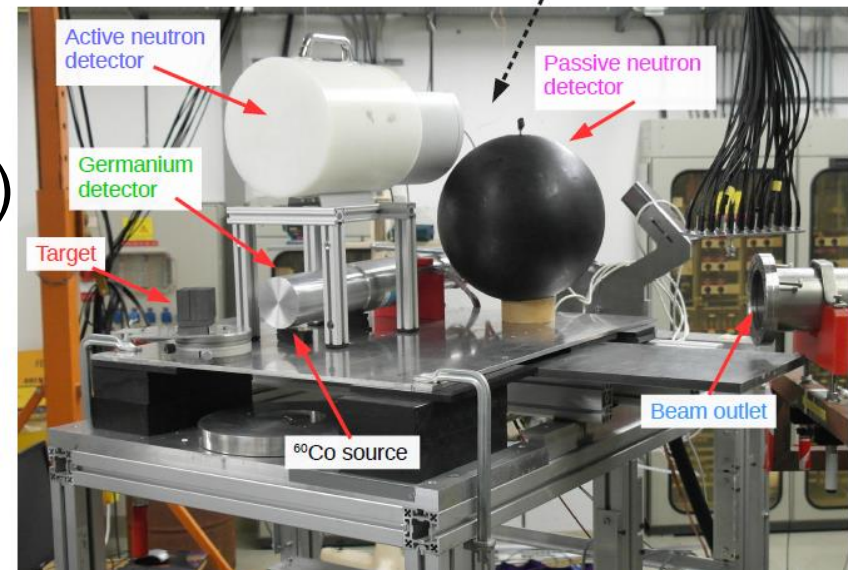
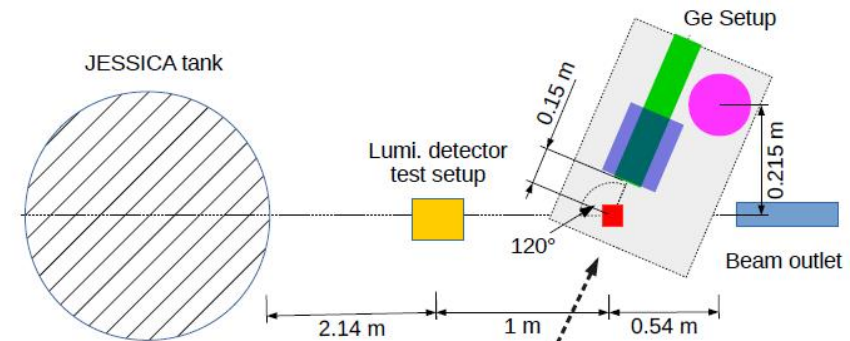

γ Spectrum after irradiation

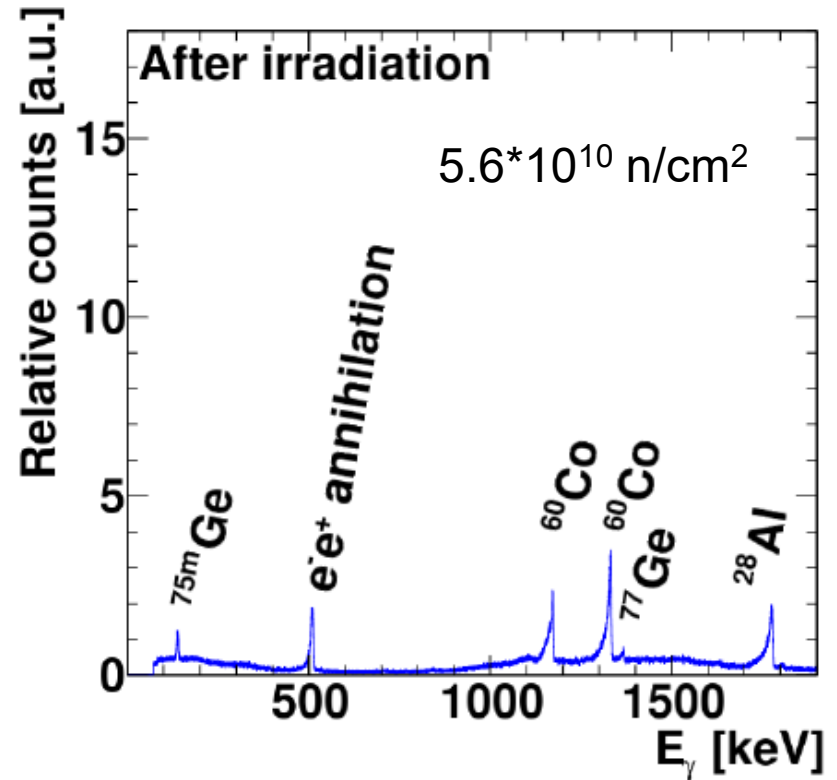
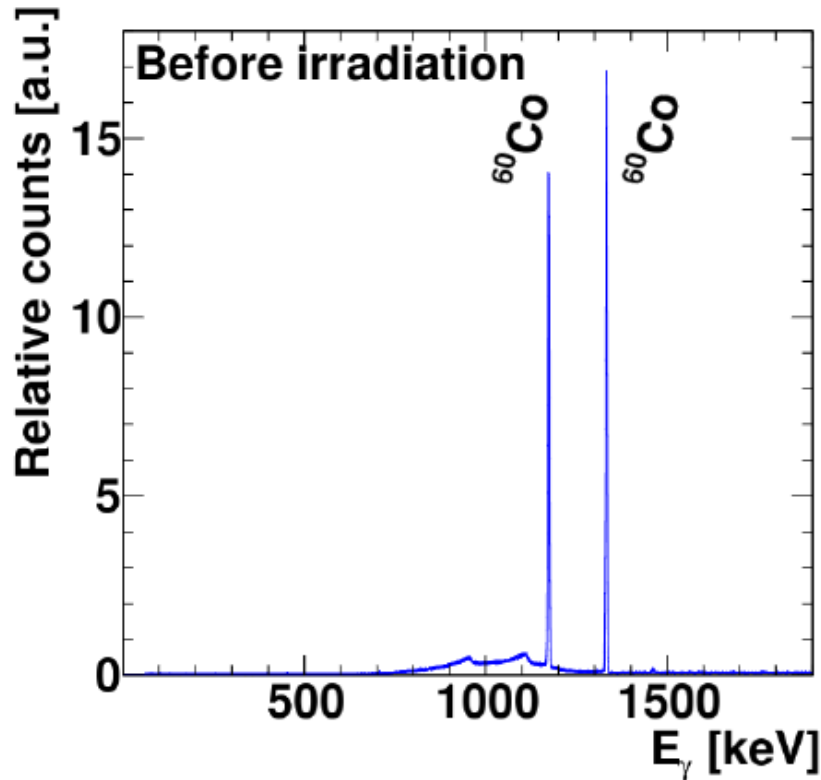

AGATA – radiation damage

- Segmented detectors
- Extract interaction position within the crystal

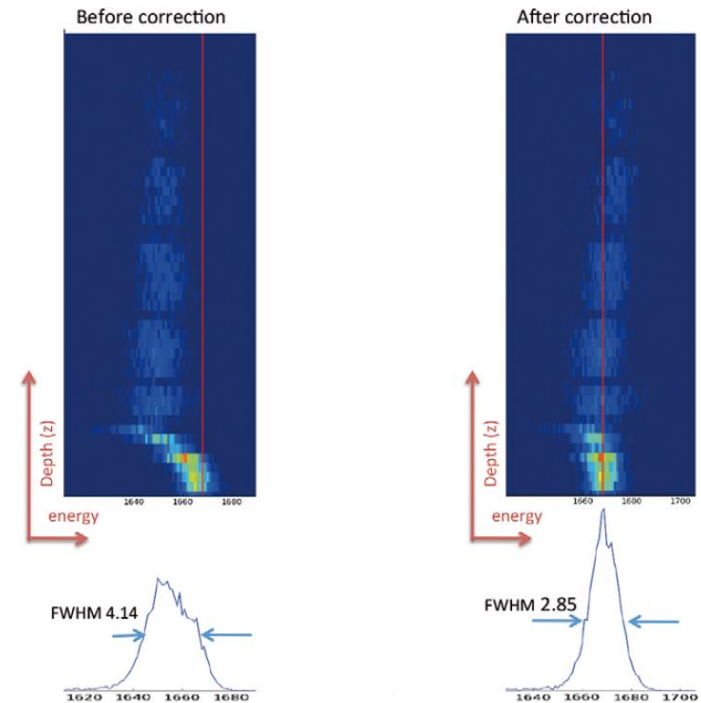
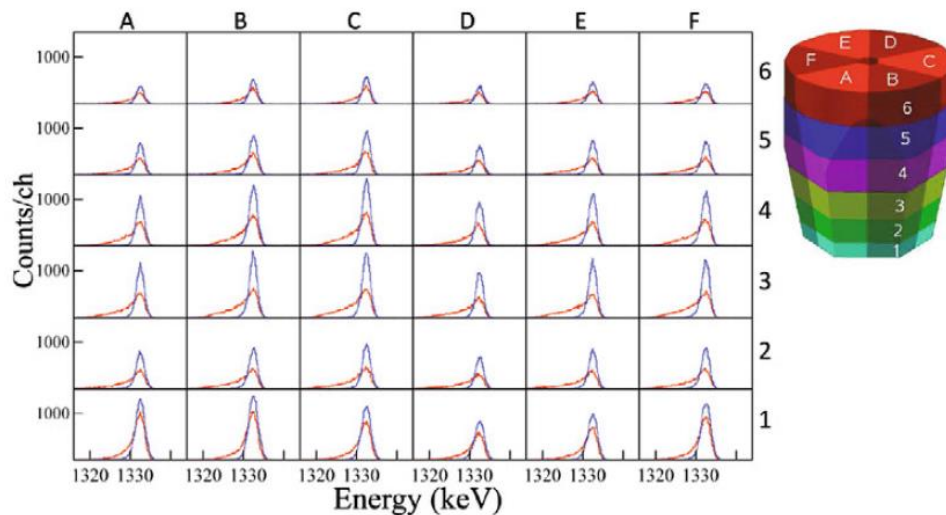

B. Bruyneel et al. Eur. Phys. J. A (2013) 49: 61

Pulse shape analysis

- EUROBALL crystals not segmented!
 - PSA allows to extract interaction depth
 - Information in rising edge
 - Rise time not unique
 - Current signal has unique r dependence
- $\rightarrow T(I_{\max}) - T(q_{10})$

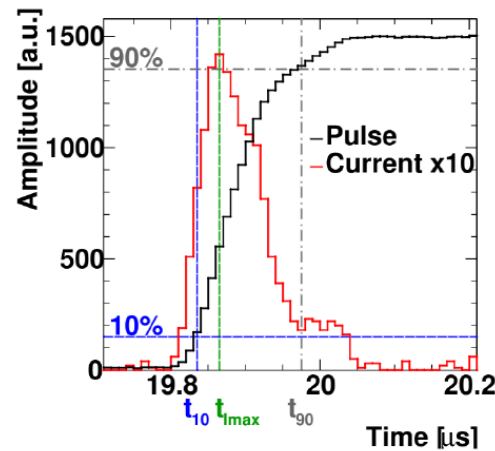
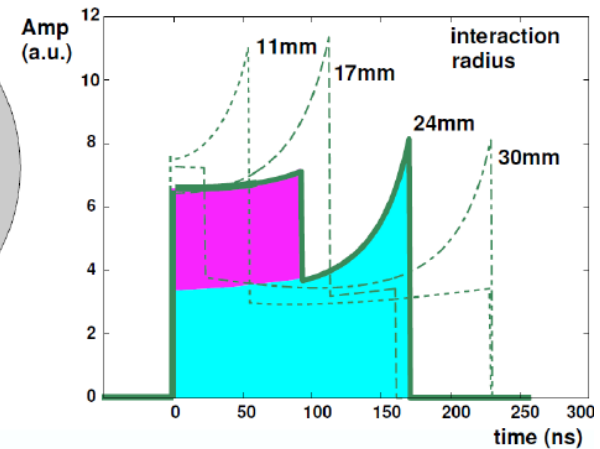
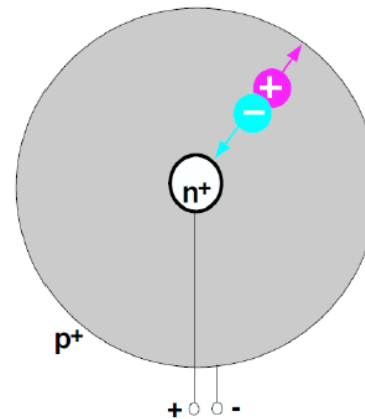

Small r

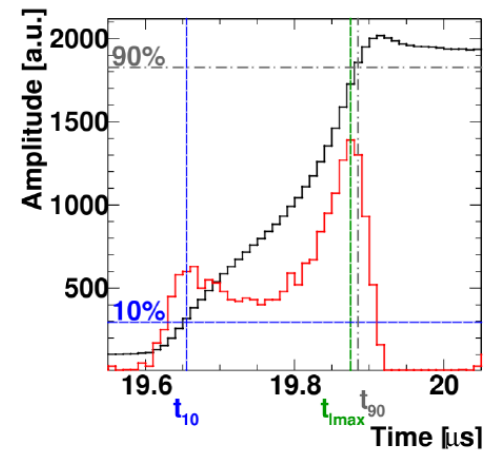

big r

fADC: CAEN v1724, 8 channel,
100 MSa/s, 14 bit

Data analysis

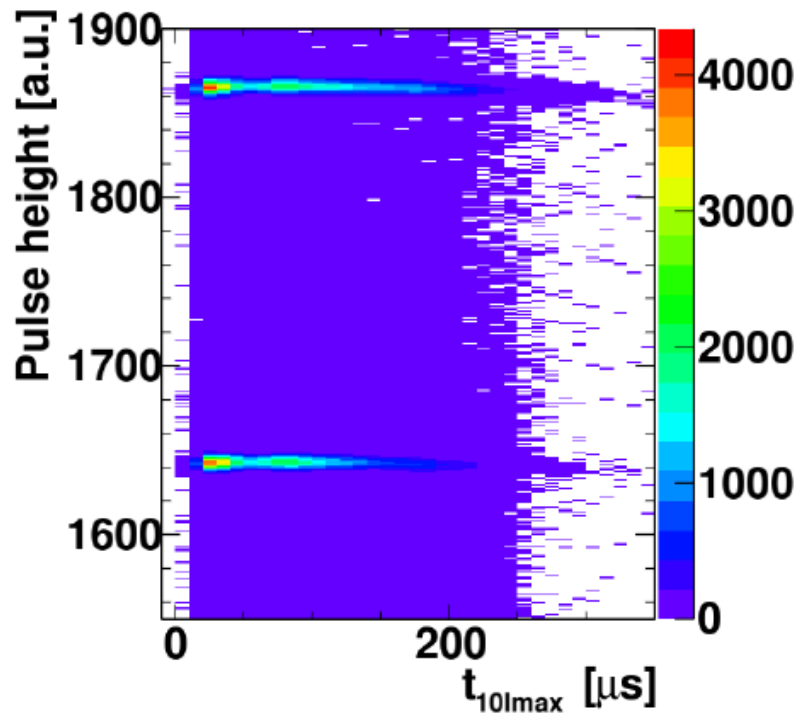

Before irradiation

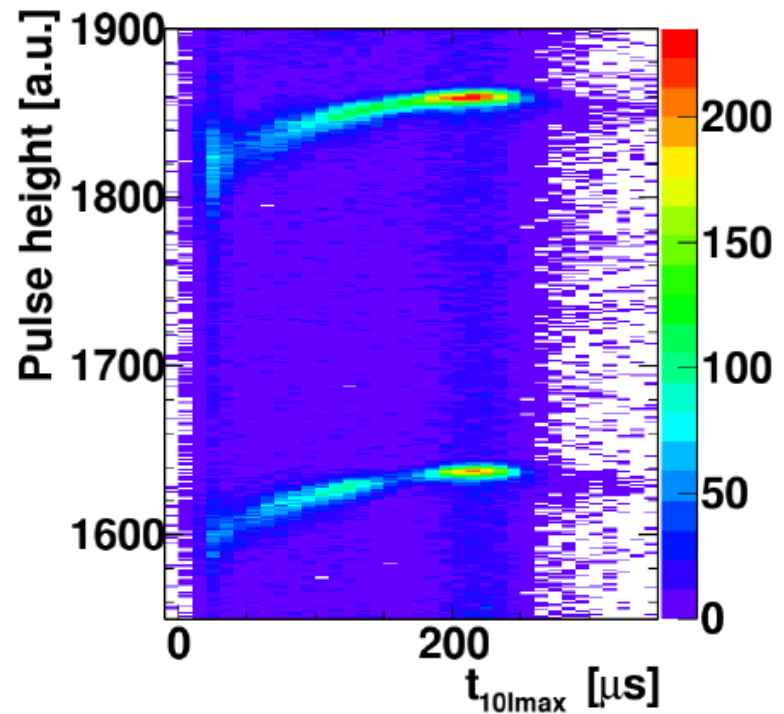

after irradiation

Application of the correction

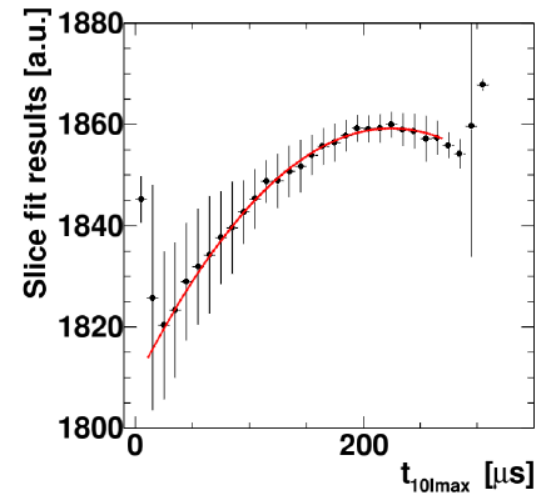
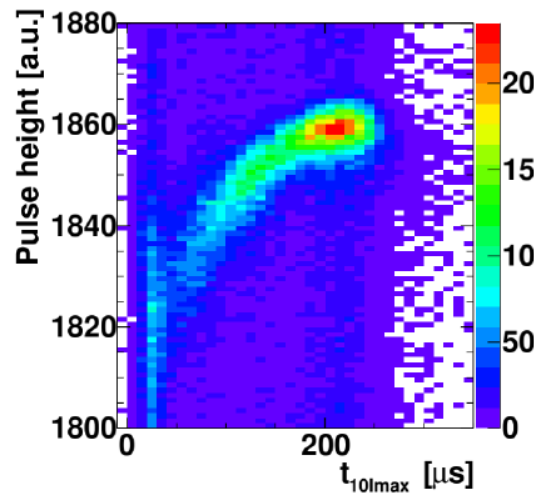

after irradiation

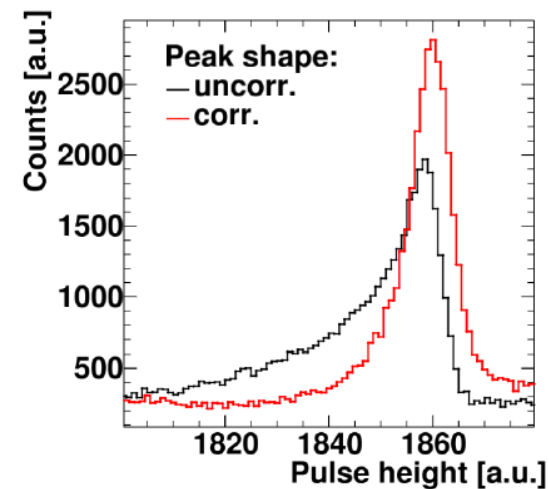
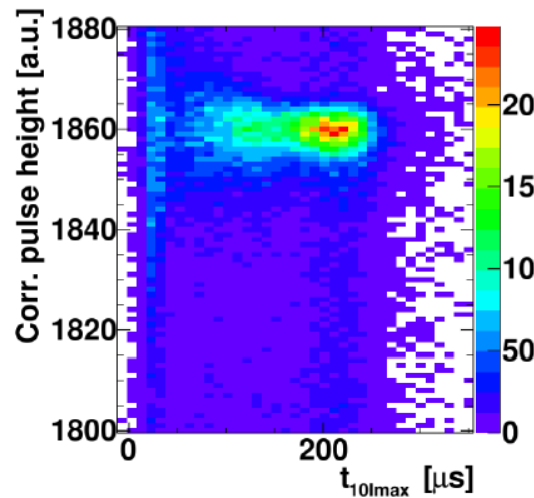

Results

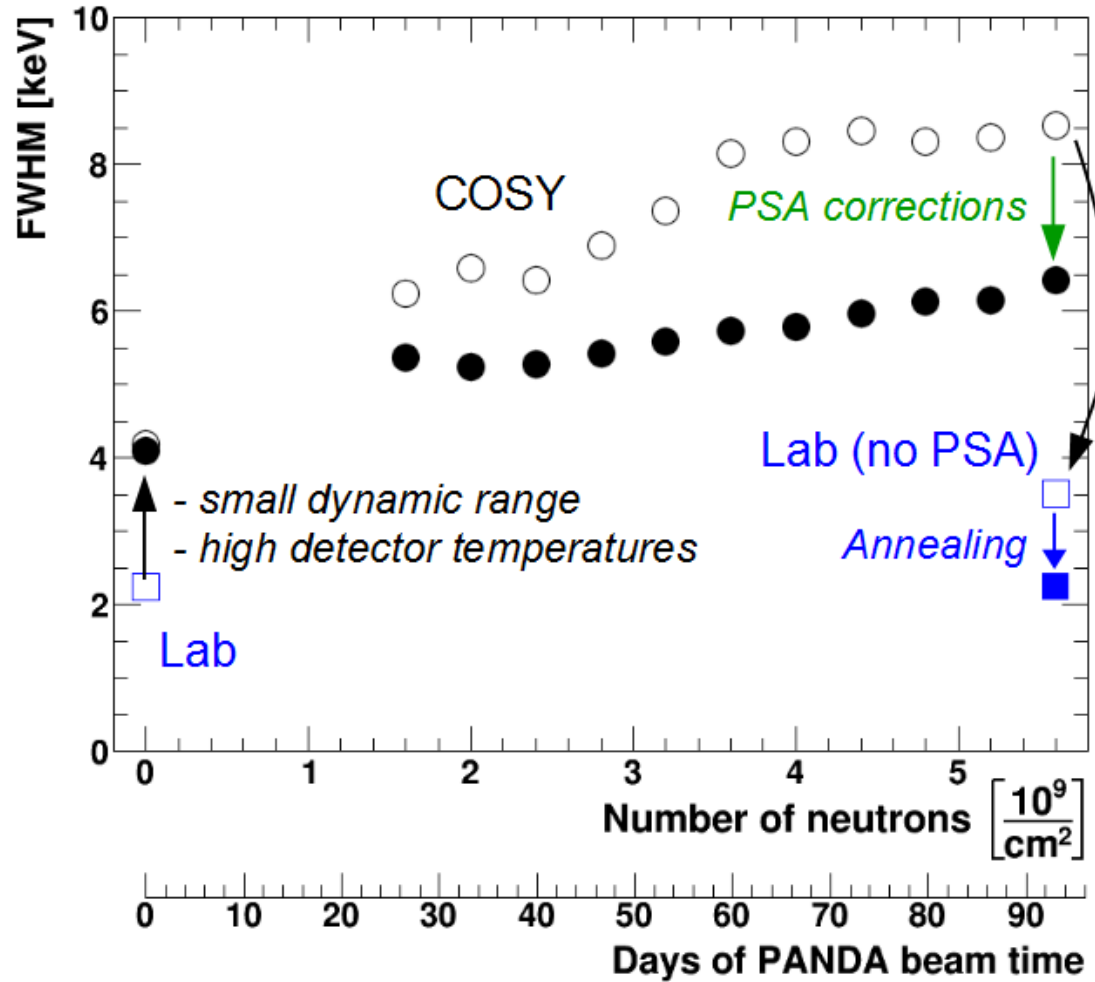

TRIGA – new tests

- More systematic test required
- TRIGA - fission reactor at Mainz university
 - Up to 100 kW
 - High flux of neutrons
 - Fast neutron spectrum poorly known
- Pre-test with scintillating detector performed in january
 - Analysis ongoing

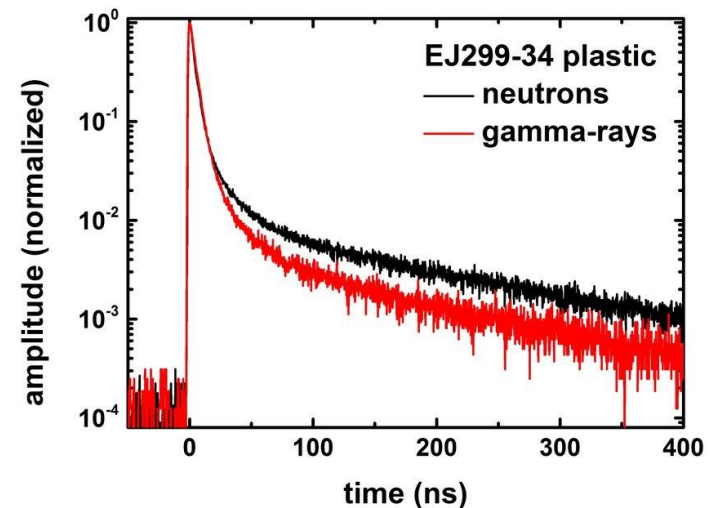
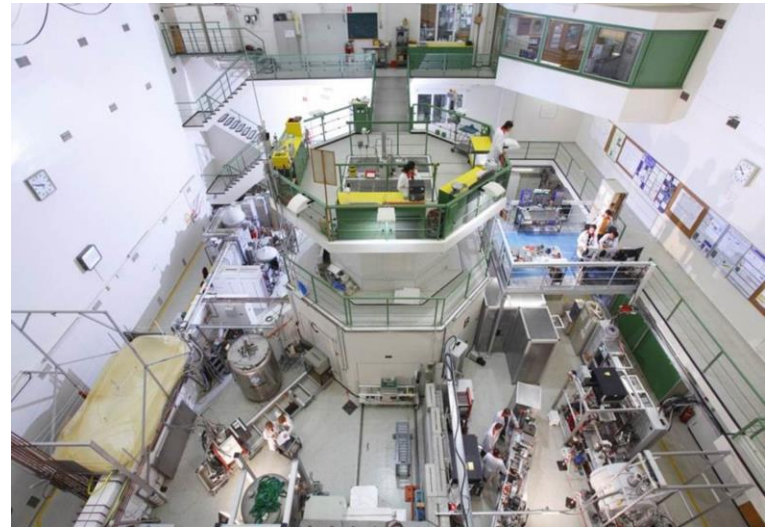

Summary

- PANGEA shares its detectors with DEGAS
- PANGEA designed to perform within \bar{P} ANDA spectrometer
- Distributed DCS system using EPICS
- Digital PSA useful to recover from the effects of the magnetic field and radiation damage